

NSS CAVERN DIVING MANUAL

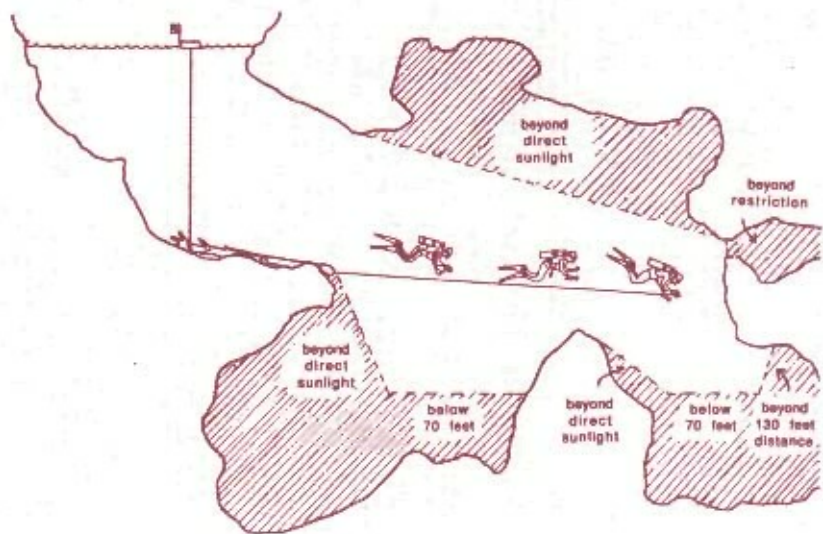

by

John L. Zumrick, Jr., M.D., J. Joseph Prosser, and H. V. Grey

Cave Diving Section of the National Speleological Society, Inc.

NSS CAVERN DIVING MANUAL

by

John L. Zumrick, Jr., M.D.
J. Joseph Prosser
H. V. Grey

with illustrations by

Wayne McKinnon
H. V. Grey



Published by
The Cave Diving Section of
the National Speleological Society, Inc.
P. O. Box 950, Branford, FL 32008-0950

All proceeds from the sale of this book beyond printing and distribution costs are donated to the Cave Diving Section of the National Speleological Society, Inc. for use in continuing cave- and cavern-diver education and safety.

First Edition, First Printing

© 1988 by the

Cave Diving Section
of the
National Speleological Society, Inc.
P. O. Box 950
Branford, FL 32008-0950
U.S.A.

All rights reserved, including the right to
reproduce this book or any portion
thereof in any form.

Library of Congress Card Catalog Number: 88-070856

TABLE OF CONTENTS

Acknowledgments.....	iv
About the Authors.....	v
NSS Policy for Cave Conservation.....	vi
Chapter 1 Introduction.....	1
Chapter 2 Cave Formation and Terminology.....	3
Chapter 3 Cave Hazards.....	1 7
Chapter 4 Equipment.....	22
Chapter 5 Buoyancy Control and Propulsion Techniques.	3 9
Chapter 6 Use of Lines and Reels.....	4 9
Chapter 7 Underwater Communications.....	5 9
Chapter 8 Dive Planning.....	72
Chapter 9 Psychological Aspects.....	82
Chapter 10 Emergency Procedures.....	91
Chapter 11 An Open Letter from the NSS Cave Diving Section to Prospective Cavern Divers.....	97
Appendix A: NSS/NACD Cavern Diver Course Description.....	1 00
Appendix B: Universal Qavern Diver Course Description.....	102
Appendix C: Cavern Diver Course Student Outline Guide.....	1 04
Appendix D: Cavern Diver Course Field Exercises Guide.....	11 0
Appendix E: Cave Diving and the NSS.....	1 1 4
Appendix F: Cave Diving and the NACD.....	1 1 6
Appendix G: NSS Publications.....	118
Index.....	1 19

ACKNOWLEDGMENTS

We would like to express our deepest appreciation to all those who helped make this long-awaited manual a reality. First and foremost, to John Zumrick, who did more than just talk about the idea of a cavern manual—and quietly authored the original manuscript. Secondly, to Wayne McKinnon, who provided most of the technical illustrations so necessary for an instructional text of this kind. And thirdly, to William L. Wilson, a Geologist with the Florida Sinkhole Research Institute at the University of Central Florida, for lending his geological expertise to the wholesale revision of the chapters on cave development and hazards. It must be clearly understood, however, that we, as the editors, take full and final responsibility for the completed text, and that all errors and inaccuracies should be blamed on us.

We would also like to thank Jeff Bozanic, Pete Butt, and Steve Gerrard for their critical review of the penultimate draft, and Mark Leonard, Wes Skiles, and Harry Averill for helpful comments and suggestions along the way.

We would like to thank the National Association for Cave Diving for graciously granting permission to use illustrations from its *Hand Signals for Diving* for the chapter on underwater communications.

We welcome comments and constructive criticisms from interested readers—especially cavern divers and cavern-diving instructors.

Safe diving,

The Editors,

J. Joseph Prosser,
Training Chairman

H. V. Grey,
Director, Publications Coordinator

April 1, 1988

ABOUT THE AUTHORS

Capt. John L. Zumrick, Jr., M.D. For more than twelve years, Dr. Zumrick was a Medical Officer with the U.S. Navy Experimental Diving Unit in Panama City, Florida. As Senior Medical Officer, he directed the testing of decompression procedures and equipment for the U.S. Navy. He has performed extensive research on hypothermia and mixed-gas saturation diving, and has participated on experimental saturation dives to depths in excess of 1500 feet. He became interested in cave diving in 1970 and has since done extensive exploration in underwater caves all over the eastern United States, Mexico, and the Caribbean. He has been involved in numerous large underwater-cave mapping projects, including the U.S. Deep Caving Team's massive dry-cave and sump-diving expedition to Sistema Hautla in the Yucatan in 1984. Dr. Zumrick has been a certified NSS-CDS Cave Diving Instructor since the beginning of the program, and has served as Chairman of the NSS-CDS, as well as Editor of *Underwater Speleology*, the bimonthly journal of the NSS-CDS.

J. Joseph Prosser. Mr. Prosser has been cave diving since 1966, and has explored underwater caves extensively throughout the United States and the Caribbean. He was certified as an instructor in 1971, and was one of the original recipients of the Abe Davis Safety Award for cave diving. He was also one of the original recipients of the ISCDA, the International Safe Cave Diving Award, which recognizes the completion of 1000 cave dives. From 1983 to 1986 he served as the NSS-CDS Training Coordinator, and was editor and principal author of the NSS Cave Diving Section's *Instructor's Training Manual*. He has written numerous articles on cave diving and diver safety, and is a nationally published cave-diving photographer. He has served on the NSS-CDS Board of Directors for several years, and is currently Chairman of the Training Committee.

H. V. Grey. H.V. Grey is an Abe Davis Safety Award recipient, and is currently Editor of *Underwater Speleology*, Chairman of the Publications Committee, and on the NSS-CDS Board of Directors.

NSS POLICY FOR CAVE CONSERVATION

The National Speleological Society believes: that caves have unique scientific, recreational, and scenic values; that these values are endangered by both carelessness and intentional vandalism; that these values, once gone, cannot be recovered; and that the responsibility for protecting caves must be assumed by those who study and enjoy them.

Accordingly, the intention of the Society is to work for the preservation of caves with a realistic policy supported by effective programs for: the encouragement of self-discipline among cavers; education and research concerning the causes and prevention of cave damage; and special projects, including cooperation with other groups similarly dedicated to the conservation of natural areas. Specifically:

All contents of a cave—formations, life, and loose deposits—are significant for its enjoyment and interpretation. Therefore, caving parties should leave a cave as they find it. They should provide means for the removal of waste; limit marking to a few, small and removable signs as are needed for surveys; and, especially, exercise extreme care not to accidentally break or soil formations, disturb life forms or unnecessarily increase the number of disfiguring paths through an area.

Scientific collection is professional, selective and minimal. The collecting of mineral or biological material for display purposes, including previously broken or dead specimens, is never justified, as it encourages others to collect and destroys the interest of the cave.

The Society encourages projects such as: establishing cave preserves; placing entrance gates where appropriate; opposing the sale of speleothems; supporting effective protective measures; cleaning and restoring over-used caves; cooperating with private cave owners by providing knowledge about their cave and assisting them in protecting their cave and property from damage during cave visits; and encouraging commercial cave owners to make use of their opportunity to aid the public in understanding caves and the importance of their conservation.

Where there is reason to believe that publication of cave locations will lead to vandalism before adequate protection can be established, the Society will oppose such publication.

It is the duty of every Society member to take personal responsibility for spreading a consciousness of the cave conservation problem to each potential user of caves. Without this, the beauty and value of our caves will not long remain with us.

Chapter 1

Introduction

Welcome to the fascinating and rewarding world of cavern diving. But watch out, because once you get a real taste of it, you may not want to do any other kind.

Mother Earth offers us a number of interesting and exciting places to dive. But few can surpass the natural splendor of some underwater caverns. Although caves, for the most part, lack the variety and abundance of plant and animal life found on coral reefs and wrecks, the spectacle of large underground rooms filled with massive boulders, water-carved walls, columns, stalactites and stalagmites, has a stark beauty of its own. Cavern diving allows you to go back in time, to explore the geological history of the Earth itself.

Many people find that exploring underwater caverns is so unlike any other activity they've ever experienced that they return home after a weekend of cavern diving wholly refreshed and revitalized. The unique environment of the underwater cavern allows them to put all of their normal workaday concerns completely aside. (Indeed, the cavern environment is such that you *have* to put all other concerns aside.)

While cavern diving is fun, relaxing, pleasant—even an esthetically stimulating adventure—it is also a serious, technically specialized form of scuba diving requiring maturity, concentration, a safety-minded attitude, and above all—specialized training.

We hope that this book will serve as a thorough reference work on the basics of cavern diving. We hope, though, that as you read through it, you will understand and appreciate the real need for classroom and in-water training with a certified cavern-diving instructor before attempting this activity. As a rule, cavern courses usually last only a single weekend—a full, but very interesting and educational weekend! As part of the course, you will do numerous open-water exercises that are designed to train you in proper cavern-diving techniques and to open your eyes

(with them shut) to the real nature of the cavern environment. You will make several cavern dives with an instructor—in the safest possible circumstances. What better way to experience the fabulous underwater cavern environment for the first time?

Cave Conservation: As geological, archaeological, and biological windows into the earth, caves have unique scientific, esthetic, and recreational values which should be preserved for future generations to study and enjoy. Although young geologically speaking, most caves have formed over the course of hundreds of thousands of years. Once defaced or destroyed, they cannot be repaired or replaced. A fragile speleothem (cave formation), such as a stalactite or stalagmite, that may have taken thousands of years to develop, can be destroyed forever in an instant.

As members of the National Speleological Society (NSS) and the NSS Cave Diving Section, we pledge to do nothing that will deface, mar, or otherwise spoil the natural beauty and life forms in caves, wet or dry. The NSS motto is:

*Take nothing but pictures,
Leave nothing but footprints (bubbles),
Kill nothing but time.*

Landowner Relations. There is no unowned land. We enter caves at the discretion of their owners—be they private individuals, corporations, or governments. Some of the most beautiful underwater caverns in the world have been closed because of irresponsible behavior on the part of divers and other casual visitors. We urge you to respect the property rights of landowners by seeking permission to enter their property and abiding by their wishes. We urge you to do everything in your power to keep these areas beautiful and clean, and to continue the welcome that divers still enjoy. You have a choice about entering a cave, but the cave has none—it's there, and it and the surrounding property are vulnerable to vandalism. Hopefully, your example might stimulate others to good conservation habits and attitudes. It's a small planet, and it's getting smaller every day.

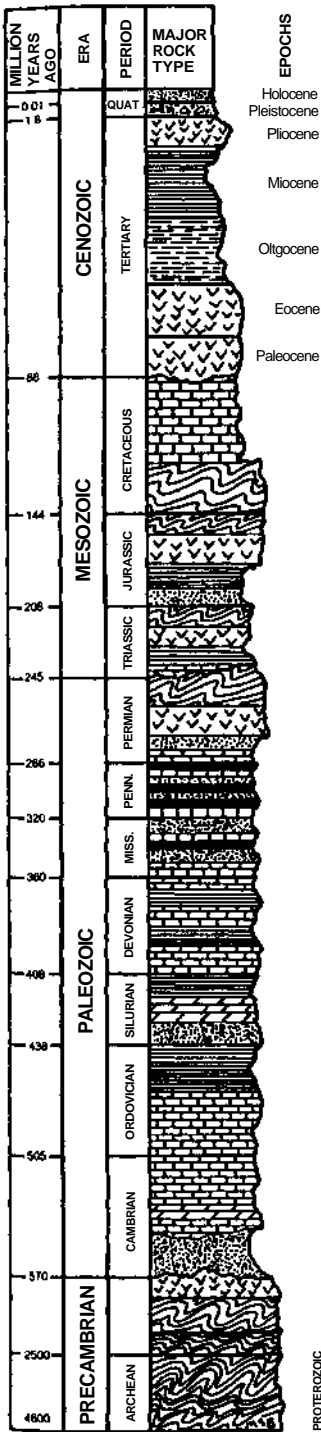

Chapter 2

Cave Formation and Terminology

Caves have played a significant role in our heritage. When we envision our prehistoric ancestors, we often think of them as "cave men," sheltering around open fires in the entrances of caves during the ice age. Much of our knowledge of early man comes from archaeological evidence preserved only in subterranean grottoes. Interestingly, however, artifacts and remains of prehistoric man have been found miles deep in caves—way beyond any conceivable need for shelter or water—indeed, sometimes in portions of the caves so remote that they require considerable climbing or crawling to reach. Clearly, early man was as fascinated by the intriguing mysteries of caves as modern man, and explored them for the same reason: insatiable curiosity. And no doubt, these prehistoric spelunkers were just as frustrated as their contemporary counterparts when they encountered a sump—a completely submerged passageway within an air-filled cave—that blocked further exploration. ...As frustrated as their contemporary counterparts, that is, until the advent of

scuba in the middle of this century.

Scuba technology has opened up exciting new vistas for exploration, allowing cavers and scientists to look into these formerly inaccessible windows into the past, into caves that have been submerged by rising sealevels since the end of the last ice age. At Wakulla Springs, which is one of Florida's largest flowing springs and deepest caves, evidence has been uncovered by cave divers which suggests that during the Pleistocene period (2,000,000 to 10,000 years ago) Wakulla was a dry cave with only a small stream flowing through it. As such it offered shelter for mastodons and mammoths, and the recovery of more than 600 bone spear points well inside the cave suggests that aboriginal man also visited the site. The shell of a giant tortoise (now extinct) with a sharp wooden stake embedded in it, found in Little Salt Spring in southwest Florida, has been carbon dated as being more than 12,000 years old. At nearby Warm Mineral Springs a human brain preserved in a skull was recovered from a submerged burial site and dated as being more than at least 8,500 years old. Other submerged aboriginal burial sites and artifacts have also been discovered in caves in the Bahamas and other Caribbean islands.

The discovery of stalagmites and stalactites—which can be formed only in air-filled caves—at considerable depths in Caribbean blue holes attests to the dramatic changes in sealevels that have taken place over the last hundred thousand years. By examining cross sections of speleothems and staining on submerged cave walls, geologists are able to more precisely determine these sealevels and their chronology. In low-lying areas where groundwater levels are high, underwater caves also provide an intimate look inside the bedrock, much of which was formed when the land areas were shallow seas. Open-water divers are not the only ones who dive coral reefs—it's just that the reefs cavern divers explore are millions of years old. But, when cavern diving, as when diving in open water, one's enjoyment and safety are greatly enhanced by an appreciation of the structure and mechanics of the diving environment, and the way in which it was formed.

A note on terminology. Geologists define "cave" as a naturally occurring room or passage in bedrock, large enough to be entered by a human being, and "cavern" as two or more such interconnected underground rooms or passages. Divers, however, have different needs

and have therefore evolved different definitions for these words. Until just the last decade there were no concepts in the English language—nor indeed, even any need for such concepts—as "cave" versus "cavern" as we have defined them to apply to scuba diving in this text. There were no unique terms (or accepted definitions of multi-faceted terms) in common English parlance or even from the scientific disciplines of geology or karst hydrology which exactly or even approximately correspond to the very precise definitions required. So, while "cave" and "cavern" as we will be defining them at length later on, do not correspond to standard technical geological definitions, they are the terms that have been adopted by the common consensus of the sport-diving community to express these unique and innovative concepts.

Cave Types. Although caves require very specific conditions in order to develop, they are extremely common and can be found throughout the world. Speleologists—those who engage in the scientific study and exploration of caves, their environment, and biology—have classified them in a number of ways, one of which is by the way they were formed. How the caves were formed will determine to a great extent the type of cavern dive a diver will have and the kinds of conditions he is likely to encounter. Of the myriad categories and sub-categories of caves, there are four basic types of caves which are frequently dived: coral caves, sea caves, lava-tube caves, and solution caves.

Coral Caves. Coral is famous for its ability to secrete calcium carbonate and build large limestone reefs. Most living reefs occur in tropical oceans and support extremely diverse communities of marine organisms. Mounds or ridges of coral may grow outward slowly and bridge across intervening open areas. Coral caves are created when the tops of neighboring coral heads grow together to create tunnels within the reef. The passages tend

to be small, short, and irregular. Projecting coral heads may snag a diver and backing out of a small cave is often very difficult. The cave floor is commonly composed of white, carbonate sand. Water clarity, as in most coral reefs, may be quite good, although the possibility always exists of clouding the

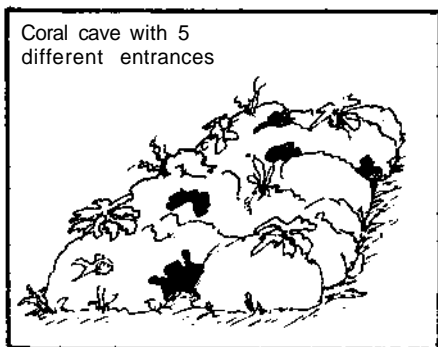

water with sediment, disturbed by the diver. Holes may exist in the ceiling and a diver may be able to see one or more alternate exits. Light at the end of the tunnel, clear water, and white sandy floors combine to make many coral caves appear less foreboding than other types of caves. However, like any diving environment with overhead obstructions, coral caves have a higher element of risk for which the diver must be prepared.

Coral caves usually contain much less marine life than the sunlit portion of the reefs. Nonetheless, solitary corals, sponges, and other organisms may be found on the ceiling, walls, and floor. Schools of small fish and lobsters commonly take shelter in coral caves. Divers should be alert for the presence of occasional large fish, such as grouper, nurse sharks, or moray eels, which can be startling when they are encountered unexpectedly in close quarters.

Sea Caves. Sea caves are formed by the hydraulic battering-ram effect of waves crashing against cliffs. There is a common misconception that sea caves form in beds of soft rock that occur at sea level and are overlain by harder rocks. However, the examination of numerous sea caves has revealed that vertical planes of weakness, such as faults, promote the development of sea caves regardless of the rock type. Many sea caves have spectacularly large entrances and some, like Sea Lion Cave in Oregon or Anemone Cave in Maine, have enormous rooms. However, passage development in sea caves is usually not extensive. Sea caves rarely exceed several hundred feet in length because the force of the waves is dissipated rapidly against the walls of the cave.

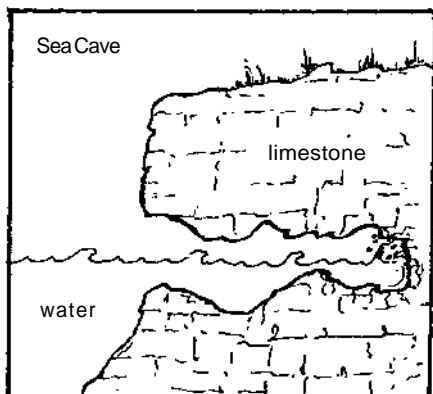

The term sea cave is somewhat of a misnomer because sea caves form along the coasts of lakes as well as along the ocean. Diveable sea caves are most common along the Pacific and northeast Atlantic coasts, but also occur in the Georgian Bay of Lake Huron, along many Caribbean islands, and along some seacoasts in Mexico. The attribute which all sea

caves have in common is that they have formed in a coastal surf zone, or littoral zone. Littoral caves may be a more accurate name for sea caves, but the name sea cave is well established and will continue to be used here.

Most sea caves are not completely filled with water. Consequently they have a lower risk from overhead obstructions than other kinds of caves. Nevertheless, submerged ledges and spaces beneath boulders may pose objective hazards, especially in heavy surf. Visibility is variable and may be poor because the heavy surf keeps particles in suspension. Check the existing conditions carefully.

Marine sea caves generally contain abundant sea life, including anemones, shellfish, sea urchins, and sea mammals. Strong, unpredictable wave wash and currents usually occur. They can drag even the strongest of divers along the floor and across sharp seashells and sea urchins, and can bash a diver with tremendous force against the walls. Thus, it is generally wise to dive in sea caves only when the tide is slack and wave height is low. Seek advice from local divers who have experience in diving the cave you wish to visit.

Lava-Tube Caves. Lava is molten rock that has been extruded from a volcano onto the surface of the earth. On an informal basis, the rock formed by the cooling and solidification of the lava is also commonly called lava, although it can be given a formal geologic name based on its mineral composition.

When lava emerges from volcanic vents and flows downhill, loss of heat to the atmosphere causes the outer layer of lava to solidify first. Sometimes the still-molten core continues to flow, draining the bridged-over area and leaving behind a hollow tube, called a lava-tube cave. If the roof is thin, as is fairly common, a number of collapses may occur at intervals along the passage,

dividing the cave into segments and providing multiple entrances. Lava-tube caves always form on dry land. Diveable lava-tube caves occur mostly along volcanic coastlines where the caves been submerged by rising sealevel over approximately the last 20,000 years.

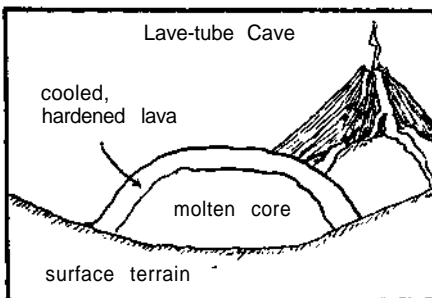

In the United States, lava-tube caves occur primarily in the Pacific Northwest and in the Hawaiian Islands. They are also found in some parts of Mexico, Africa, and the Canary Islands. Lava-tube caves are often simple conduits, but extensive branching or maze-like passages are sometimes found. Roof collapses may partially or completely block a passage with boulders. Ape Cave, in the State of Washington, has over 12,000 feet of passage with widths up to 10 feet and heights of up to 40 feet. Kazumura Cave, in Hawaii, has over 7-1/2 miles of surveyed passageways that are complex in their design. Both Ape Cave and Kazumura Cave are dry caves.

Because most lava tubes explored by divers are found along seacoasts, these caves share many of the same features associated with coral caves and sea caves. Marine life, and wave and tidal effects must be carefully considered when planning a dive and during the dive itself. A couple of other potential hazards should be noted by prudent divers. Most lava-tube caves are formed in a dark-gray-to-black rock called basalt. The dark color of the rock causes it to absorb tremendous amounts of light. Lava-tube caves may also contain extensive amounts of clay and silt that can reduce visibility to zero if stirred up by a diver.

Solution Caves. Solution caves are by far the most numerous and extensive type of caves found. The Flint Ridge-Mammoth Cave System of Kentucky is presently over 400 miles in length and is constantly expanding as exploration continues. Solution caves also contain the largest underground chambers. The Big Room of Carlsbad Caverns in New Mexico, for example, is over 300 feet high, 600 feet wide, and 4000 feet long. Most cave diving takes place in caves of this type.

Solution caves derive their name from the fact that they are formed by the dissolution of certain kinds of sedimentary rock, such as limestone and dolomite, by weakly acidic, flowing groundwater. Limestone and dolomite occur over approximately 15 percent of the world's land surface. In North America solution caves are found wherever carbonate rocks crop out, such as in belts along the folded (western) part of the Appalachian Mountains; throughout much of Kentucky, Tennessee, Alabama, and Georgia where the limestone is nearly horizontal; in the Ozark Mountains of Missouri, northern Arkansas, and eastern Oklahoma; in the Edwards Plateau region of central Texas; in and along the flanks of numerous mountain ranges in the Rocky Mountains; in

northern and central Florida; in the Yucatan Peninsula of Mexico; and throughout the entire Caribbean archipelago. The solution caves most frequently dived are located in Florida, the Bahamas, Texas, Missouri, and Mexico.

Soluble Rocks. The two kinds of soluble rocks that are important for cave diving are limestone and dolomite. They are called carbonate rocks because of their chemical composition, and dissolve more readily than most other rock types. Limestone is a rock made of calcium carbonate (CaCO_3), and dolomite (also known as dolostone) is a rock made of calcium-magnesium carbonate ($\text{CaMg}(\text{CO}_3)_2$).

Limey sediment is produced most abundantly in shallow tropical oceans where the water is relatively clear and free from silicious sediment. Nearly all of the lime is derived from the calcareous skeletons of animals and certain types of algae, although a minor amount of calcium carbonate is deposited directly from the seawater. Layers of limey sediment may accumulate and be buried in areas where the crust of the earth is subsiding. This subsidence may occur over millions of years. Eventually the limey sediments may reach depths where the pressure and temperature are high enough to lithify the sediment, turning it into rock.

Lithification is accomplished by compaction, partial or total recrystallizations, and cementation of the limey sediment. The texture of the limestone may range from large, solid colonies of intergrown coral, to seashells to sand-sized, broken bits of shells, to microscopic crystals. Limestone is a tremendously variable type of rock and this description barely begins to explore the possibilities.

Dolomite is usually formed from limestone by a chemical reaction with magnesium-rich brine after the original limey sediment is deposited. Because dolomite is commonly a replacement product, it often has a smooth, fine-grained texture and may have very few or no fossils. Dolomite is usually light brown or buff colored; it is slightly darker than most limestone and as such, is easily recognized by most cavern divers.

If the limestone is buried at sufficient depth for a long enough period, then the pores between the limey grains may be filled with calcite (a crystalline form of calcium carbonate). If the amount of pore filling is sufficient to close the pores from one another, it makes the rock impermeable to water. Much of the

limestone in the Midwest of the United States has this low primary porosity. On the other hand, limestone that has been buried at shallow depths for short periods may have much of its original pore space, thus making the bulk of the rock permeable to water. Florida and many islands around the Caribbean Sea have limestone with high intergranular porosity.

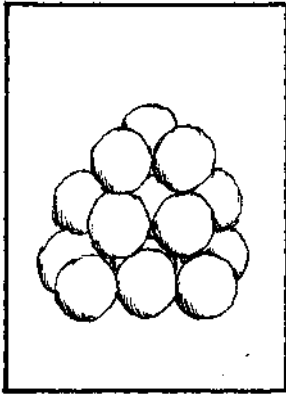

LEFT. Porous and permeable sand with open, interconnected voids which allow the free movement of water.

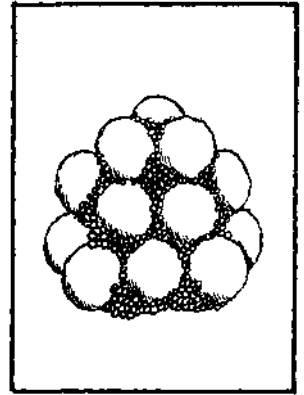

RIGHT. Porous sand rendered impermeable because of interstitial material such as clay, preventing the free flow of water.

Hydrogeology. Caves can form in soluble rock wherever a source of acid is present and groundwater flow is sufficient to carry away the products of dissolution. Scientists have identified a number of sources of acid, but the most important one by far seems to be carbon dioxide, which occurs as a gas in the atmosphere and, more especially, in the soil. Carbon dioxide is produced in moist, organic-rich soil by the respiration of microorganisms and the processes of decay. Rainwater filtering down through the organic matter in soil absorbs carbon dioxide to form carbonic acid (H_2CO_3). Although carbonic acid is weak, over time it can dissolve sufficient limestone or dolomite to form a cave.

Near the surface, the soil and/or bedrock may contain both tiny air pockets and infiltrating water. This zone of aerated material is known as the vadose zone. Eventually, the downward percolating water reaches a depth where the pores and joints are completely filled with water. The water-saturated portion of the ground is called the phreatic zone. The top of the phreatic zone is called the water table.

Horizontal and vertical cave passages can form both above and below the water table. The relative importance of cave development above or below the water table has been debated at great length. A consensus has developed that most cave

development initially takes place a short distance below the water table in the shallow part of the phreatic zone. Acidic water flowing through joints in the vadose zone tends to drop vertically to the water table. At the water table, the downward flow is impeded because the pores and joints are filled with water. Consequently, once the water reaches the phreatic zone it tends to move laterally from areas where the water table is high, to the lowest available outlet. Local geologic, geographic, and environmental conditions can greatly influence the type of cave that can develop and control the hydrologic function of the cave. A wide variety of forms and functions are possible.

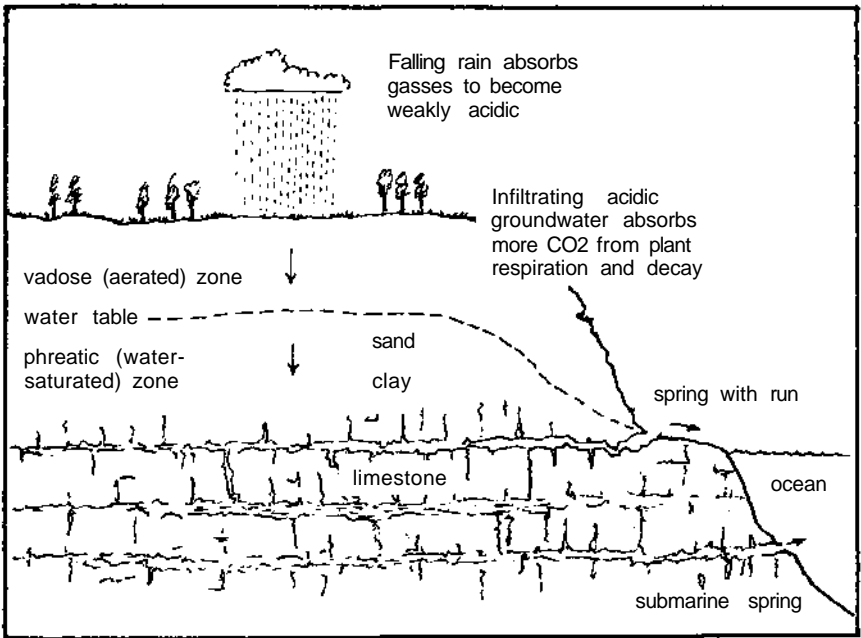

Karst Terrain. Areas where soluble rocks occur at or near the surface usually develop a distinctive landscape called karst terrain, characterized by the presence of sinkholes, sinking streams, caves, and large springs. The term karst is derived from an area in northwestern Yugoslavia, called the Carso Plateau, where karst features were first described scientifically. Karst terrain is usually typified by the absence of, or distinct reduction in, the number of surface streams. Most of the drainage is

diverted underground in upland areas, flows through caves toward low-lying areas along major river valleys or the seacoast, and is discharged through springs into lakes or oceans, or to flow again in surface channels.

Water Sources. There is a common misconception among divers new to cavern diving, that the water conduits supplying the local springs flow for hundreds of miles underwater, just as surface rivers do. Although there are a few documented instances of underground rivers running for tens of miles, the output of the flows of most major springs can be accounted for on the basis of rainfall within a relatively restricted surface region. For example, the drainage basin for Rainbow Springs, one of Florida's first-magnitude springs, is only in the neighborhood of 25 x 35 square miles. However, in some cases flows may originate from sources under tremendous pressure thousands of feet below ground. The water from Warm Mineral Springs, for example, is thought to come from the 3000-foot boulder zone.

Springs. A spring is a point where a concentrated flow of water emerges from the ground. In karst areas, a spring commonly consists of the mouth of a cave from which a very large amount of water may be discharged, although some large karst springs are occluded by sand or boulders that make entry into the cave impossible. These karst springs may flow as surface streams out of caves that are either partially dry or completely filled with water. Cave springs can also open directly into the floor of a river, lake, or ocean.

The largest karst spring in the United States is probably Silver Springs, near Ocala, in central Florida. Silver Springs

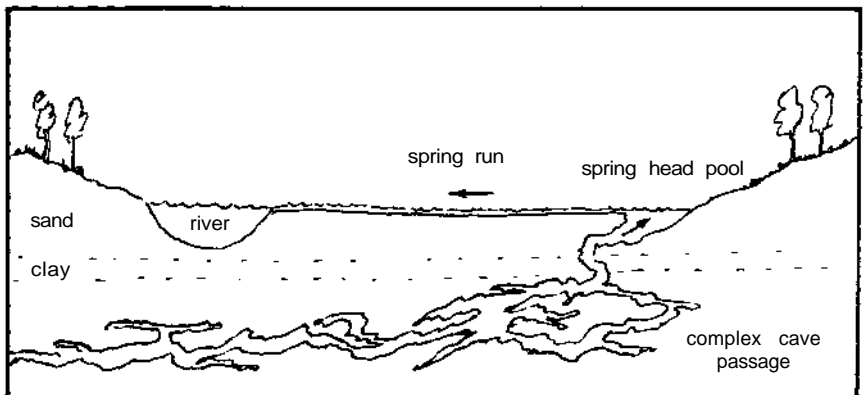

discharges 960 cubic feet per second on average. Certain other, closely related groups of springs have average discharges that total even more. Any spring that has an average discharge of more than 100 cubic feet per second (64.4 million gallons per day—or about the amount of freshwater required each day for a city of 100,000) is classified as a first-magnitude spring. Based on available publications, there are 27 first-magnitude springs in Florida, 15 in Oregon, 14 in Idaho, 8 in Missouri, and 4 in California.

The cave springs that are of interest to divers are, of course, the ones that are completely filled with water. Cave springs commonly appear as pools from which a stream, or run, flows. Frequently, a smooth area, or slick, occurs on the surface of the spring pool above the mouth of the cave. The water discharged from a cave spring flows down the run to a larger surface stream, lake, or the ocean. Spring runs are usually less than a few hundred yards long, but in some cases, like Ichetucknee Springs in Florida, they are several miles long.

Siphons. The point at which part or all of the water of a sinking surface stream sinks into the ground or enters a cave is called a swallow hole, or ponor, or—particularly by divers—a siphon. Instead of having a slick on the surface like a spring pool, a siphon pool will commonly have floating debris and water plants revolving slowly above the cave opening in a spiral pattern called a gyre. This whirlpool-like feature is a telltale indication that water is flowing into the ground. Siphons may drain entire rivers, as is the case for the Chipola and Santa Fe Rivers in Florida, which sink underground only to reappear miles away. Diving in siphons is much more hazardous than diving in springs because of the inflowing current, which must be overcome to exit the cave, and because the inflowing river water may have poor or no visibility.

Sinkholes. Karst terrain is characterized by numerous depressions in the ground surface, known as dolines, or sinkholes. These depressions may be shaped like bowls, downward-pointing cones, or cylinders. Sinkholes may range from less than one foot to several hundred feet deep. Widths vary from less than one foot to several thousand feet. Water flows toward the bottom of the sinkhole and generally soaks into the ground. Solutionally enlarged openings in the bedrock, often filled with soil or broken rock, usually connect the sinkhole to an interconnected cavern

network. Sinkholes, therefore, serve as the input points from cavernous drainage.

Sinkholes are formed by three principle mechanisms. First, solution may produce a depression on the top of bedrock, thus forming a solution sinkhole. Second, a cave roof may collapse causing the overlying ground to settle and forming a bedrock cavern-collapse sinkhole. Third, soil or unconsolidated material, may wash downward into pre-existing voids in the bedrock, thus causing the surface to subside, and forming a subsidence sinkhole. Subsidence of the cover material may be very rapid or very slow, so subsidence sinkholes can be subdivided into cover-collapse (rapid) and cover-subsidence (slow) sinkholes. In either case, subsidence is caused by erosion that starts at the base of the soil, or unconsolidated material, and works its way up to affect the surface. Subsidence sinkholes are by far the most common type of sinkhole in areas where appreciable soil cover exists, as in much of Florida. Bedrock cavern collapse sinkholes are perhaps the easiest to visualize, and they do occur, but generally they are much less common.

The floor of a sinkhole may be bare rock or be covered with soil, or contain a cave entrance. The floor may be dry or flooded. A sinkhole with water in the bottom is called a karst lake or karst pond, or less properly, a sinkhole lake. Karst ponds may range in width from a few feet to several hundred feet. Although they may be small, they may be hundreds of feet deep.

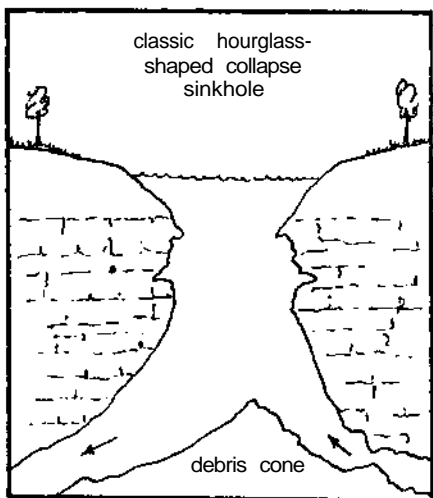

Some karst ponds have a cave entrance in the floor of the pond. In Florida, the entrance commonly leads down into a vertical shaft. At depth the walls may widen and thus create large overhanging ledges. In cross section, the sloping floor of the pond and the increasing width of the cave frequently have an hourglass configuration. If soil has washed down from the surface or if much rock has fallen from the ceiling, a cone of debris may be present on the floor of the cave.

Horizontal caves may be present anywhere along the walls of the vertical shaft. If little collapse or sedimentation has occurred, then one might find two cave passages at the bottom of the shaft, one leading upstream and the other leading downstream. Divers call the upstream passage the spring cave and the downstream passage the siphon cave. When used in this sense, the terms spring cave and siphon cave simply denote the relative direction of current flow.

Cenotes. Cenotes are vertically walled or slightly overhanging shafts in bare or thinly mantled limestone terrain, and were first described in the Yucatan Peninsula of Mexico. The width is approximately equal to the depth in a cenote, and the bottom of the shaft contains water. In plan view they are approximately circular. Generally cenotes have been considered cave-collapse sinkholes, although some geologists have proposed that coalescing vertical shafts may have formed some cenotes. Dismal Sink, south of Tallahassee, Florida, is a good example of a cenote.

Karst Windows. Karst windows are cavern collapses that reveal a segment of a stream that otherwise flows through an underground course. The type section for a karst window was originally defined as Twin Caves in Spring Mill State Park, Indiana. In a karst window, the upstream and downstream sections of the cave are separated by a short segment of stream channel that is exposed to the surface. Divers often call such features spring-siphons in reference to the direction of flow in the upstream and downstream sections of the water-filled cave passages at opposite ends of the karst window. But karst windows are definitely *not* springs because the cavernous flow is not discharged to the

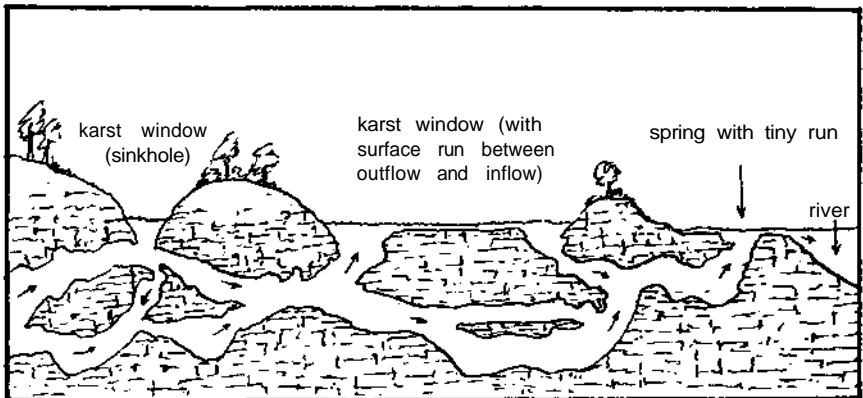

surface, but merely revealed through a hole in the ceiling of the cave. An excellent example of a karst window is River Sink, south of Tallahassee, Florida. Flow emerges from the north side of a pool that is 65 feet wide and 280 feet long, and passes into an underground channel at the south end of the pool. River Sink is *not* a spring, however, even though it is listed as a first-magnitude spring on most lists of large springs in Florida. The flow from River Sink probably emerges further south, at Wakulla Spring, which forms the headwaters of the Wakulla River.

Sumps. A water-filled section of cave passage within a cave that has other passages that are at least partially air filled, is called a sump. Sumps occur where the passage descends to a lower elevation below the water table, or the roof becomes low enough that the cave stream can fill the passage. In some cases a sump may lead to more air-filled passage. Sump diving is the most advanced form of cave exploration since it requires both caving and cave-diving skills. Significant difficulties that may be encountered on a sump dive include transporting equipment long distances through rugged passage, fouling of gear by mud and sand, cold water, no visibility in the water, numerous tight restrictions, and mental and physical exhaustion. Sump exploration is, therefore, best left to those specifically trained for these demanding conditions.

Underground Lakes. Very large sumps are sometimes referred to as underground lakes or sump lakes. They are more common in mountainous regions, although several are documented in Florida. The Lost Sea, a commercial cave in Tennessee, contains the largest underground lake in North America, with a surface area of 4.9 acres. Dragon's Breath Cave in Namibia, Africa is the world's largest underground lake, with a surface area of 5.2 acres and visibilities exceeding 300 feet. The prospect of such good visibilities can tempt the uninitiated diver. However, because of the lack of natural daylight and potential disorientation of underground lakes, they must be accorded all the respect due to any sump as a technically advanced cave dive.

A basic understanding of the principles involved in cave formation and dynamics gives us a modicum of appreciation for their fascinating history and a preliminary insight into the hazards they present to divers. The next chapter will examine these hazards in more detail.

Chapter 3

Cave Hazards

The obvious hazards of water, ceiling, and darkness are found in all underwater caves and are generally anticipated even by those cavern diving for the first time. However, the underwater cavern environment presents certain unique hazards that most divers are not prepared to deal with. For example, although diving in the darkness of a cavern may seem akin to night diving, the cavern ceiling limits direct ascent to the surface. This requires that the diver return to the surface by swimming horizontally, as well as vertically, along an often circuitous route. Other, more specific hazards, which may not be present in all underwater caves and which occur at various levels of severity, include currents, loss of visibility, restrictions, large passages, mazes, line traps, and cave-ins.

Current. Underwater caves contain currents of varying strength and direction. The current in some caves may be nearly imperceptible while in others it may be so severe that a diver might be unable to swim against it. The strength of the current within a given cave can vary depending on recent weather. If recent rainfalls were light and steady, much of this water is absorbed into the ground. This minimizes surface runoff to local rivers, and currents in the caves that drain the area will be stronger than normal. Alternatively, when heavy downpours cause rivers to rise rapidly, current within the cave will be low and the direction of flow may even reverse. Thus, a cave that is normally a spring may temporarily become a siphon.

Some caves may contain several tunnels, some of which may be outflow tunnels, while others are siphon tunnels. The combination of spring and siphon tunnels within the same cave is a common feature of sinkholes. In other underwater caves current direction may change in response to local tides. This is a prominent feature of marine caves, such as ocean blue holes, lava tubes, cenotes, and sea caves, where strong outflows tend to occur with an outgoing tide and strong inflows, with an incoming tide.

Since the currents in these caves may be extremely powerful, most of them are safe to dive only during the short periods of the day when current is slack.

Conditions Affecting Visibility. Caves can provide some of the clearest water found, with visibilities sometimes exceeding several hundred feet. However, visibility may vary considerably in different caves and within the same cave at different times of the year. Visibility depends upon two things: the amount of suspended particulates and the dissolved chemicals in the water.

Silt. Geologists classify particulates by their chemical composition (organic vs. inorganic), and by their size ("sand" being 2.0-0.064 mm in diameter, "silt" being 0.064-0.002 mm, and "clay" being less than 0.002 mm). Divers typically refer to all fine-grained particles as silt, and the act of stirring them up as silting. Total loss of visibility due to silting is called a siltout. Cave divers categorize silt particles in terms of how easily they are disturbed and the length of time they remain suspended in the water—in essence, by how they immediately affect visibility. The subcategories cave divers use are sand, mung, mud, and clay.

Sand is a relatively heavy, coarse material, composed of ground-up rock or mineral, usually with a light-colored, clean appearance. If disturbed, it tends to settle out of the water very quickly, usually within a matter of minutes. Mung, which is organic growth that occurs in marine caves, varies in size, but is very lightweight and tends to remain suspended for considerable lengths of time. In low-flow marine caves, mung tends to cover everything. Mud, which may be either organic or inorganic, does not have the loose, "dry" appearance of sand, but looks more like mud on the surface. More often than not, it is dark in color, and once disturbed, may take several hours to settle. Clay is the most treacherous form of silt because it is very fine grained, and once stirred up, may take days or even weeks to settle out of suspension. These dust-like particles are so fine that, when stirred up, a diver may not be able to see a bright light held only inches away from his facemask. A little clay can go a long way. For example, a small amount of clay clinging to a submersible pressure gauge that has been dragged carelessly along the bottom, may create a cloud of silt that follows the diver throughout the cavern.

Silt particles may be either loosely or tightly compacted. For example, if you were to accidentally drop a light on a hard-packed mud floor, it would stir up a little puff of silt, but would

rest solidly on the surface. If, however, you were to drop it on a very loosely compacted clay floor, it would not only stir up a cloud of silt, but be swallowed up completely.

The nature of the silt and degree of compactness may change significantly within a particular cave. The amount of silt, type of silt, and ease with which it can be disturbed, varies depending on the velocity of the current and the type of sediment available in the area around the cave. Passages with strong currents may contain only sand, gravel, or have bare rock walls. On the other hand, because small particles accumulate where the current is low, soft and easily disturbed silt is most likely to occur in passages that have little or no current. Because of gravity, sediment is usually thickest on the floor of the passage, and on ledges. But layers of sediment can also be weakly attached to the walls and ceiling, and partially eroded mud banks may form the wall in places. Because of this, even the most cautious diver may cause some silting, if only because his exhaust bubbles disturb the ceiling silt.

Chemicals. Tannic acid, which is produced by decaying vegetation in swampy areas, imparts a dark brown tea color to water. Obviously, caves that siphon river water tainted with this brown pigment have very poor visibility. Another chemical, hydrogen sulfide, is frequently found at the interface between the freshwater and saltwater layers that occur in some sinkholes, especially those lying along coastal regions. Although no toxic reactions due to hydrogen sulfide have yet been reported in divers, hydrogen sulfide can cause visual distortion because of the way it refracts light. Since all surface light is usually lost below a hydrogen-sulfide layer, cavern divers should always remain in the freshwater above. A third kind of visual impairment occurs in marine caves which have layers of water with different concentrations of salt. Visual distortion can occur when looking through one layer to another, and when swimming along the interface between layers, or halocline.

Weather and Geography. The amount of particulates and chemicals found in the water at the beginning of a dive depends in a large part on the weather and presence of sinkholes. Heavy rains will wash tannic acid and particulates into sinkholes, decreasing visibility in the cave. Thus, the visibility in cave systems which are located near marshy areas and have numerous sinkholes, is limited during the rainy season and clearest during extended droughts. On the other hand, springs located along rivers in areas that lack sinkholes and where the surrounding terrain is dry and

sandy, tend to be very clear. Only when the rivers rise, causing the springs to reverse flow, can dark river water be found in these caverns. Reversing tidal currents in blue holes may also alter visibility by bringing turbid ocean water into the cave.

While the water visibility may change due to conditions outside the diver's control, such as a sudden rainstorm that washes mud into the cavern, loss of visibility during a dive is most frequently caused by diver silting. With the careless flip of a fin, a diver may reduce visibility from hundreds of feet to near zero. The consequences of silting vary in different caves. Silting is most serious in caves which contain little or no current. In small passages, even a minimal amount of silting will obscure a diver's visibility from floor to ceiling, while in a larger cavern, he may be able to ascend into clearer water near the ceiling to exit the cavern.

Restrictions. Localized narrowings of cave passages are called restrictions. Precise definitions of types of restrictions by cave divers are subjective and tend to reflect the degree of difficulty involved in negotiating them. As a cavern diver you must be careful to avoid any restriction where you and your buddy cannot swim side by side or turn around easily. Beyond such a restriction, air sharing and line following, not to mention silt control, are greatly complicated.

Large Passages and Mazes. In large passages, particularly when visibility is poor, divers may be unable to see the cavern walls, floor, or ceiling clearly. Suspended in a sea of blackness and without a stable reference point, a diver can easily become disoriented and lost. Even when the cavern is clearly visible, passages frequently look quite different when you are returning the other direction, making it easy to become confused, especially if the cave is a complex maze. To avoid getting lost you must always maintain a continuous guideline to the surface, and remain within easy reach of the line at all times. You can maintain better orientation in such a cavern if you are careful to route the guideline along a wall or the floor rather than in midwater.

Line Traps. Cavern passages are rarely uniform in size. Many that are large enough to enter easily on one side taper to a narrow slit too small to accommodate a diver on the other side. If you allow your guideline to be pulled into such an area as you explore, and then silt the cave, you may be unable to find your way out even with the guideline. In such a situation the line will seem to pass right into the cavern wall. Avoid getting your line caught

in such areas by routing it around rock outcroppings and along walls, and by maintaining tension on the line at all times to hold it in place. If a line is pulled into a line trap, you can free it by moving the line sideways along the crack until you locate the larger part of the tunnel.

Cave-ins. Most aspects of cave formation occur only very slowly, over the course of thousands, even hundreds of thousands, of years, although said to occur "rapidly" in terms of geological time frames. However, there is one aspect of cave development which occurs "rapidly" by almost any standards, and that is the cave-in. While hardly an everyday occurrence, ceiling collapses and breakdowns are a normal part of the evolution of caves. The rocks and boulders and rubble piles that you will see on the floors of many underwater caverns are the results of such ceiling collapses. Although there are several documented instances of cave divers encountering evidence of fresh breakdown (noticing substantial changes in the cave itself from one dive to the next), such occurrences are relatively rare. However, there can be no absolute guarantees about the stability of any natural underground cavity.

When a cave is submerged at all times, the water inside serves as a steady, constant support to the rock above. This situation is generally much more stable than that of an underground cavity that is subjected to alternating periods of partial and complete submergence, accompanied by drastic changes in the groundwater saturation of the surface bedrock forming the ceiling, which place tremendous strain on the support structures. Ultimately, the ceiling may be weakened to the point where it gives way. Collapse sinkholes as a genre are formed by such sudden, dramatic ceiling collapses. Some sinkholes are quite ancient, and therefore relatively stable and safe. Others are more recent, or even active—and visibly unstable—and should obviously not even be considered as potential recreational diving sites.

Chapter 4

Equipment

Nowhere is a diver more dependent on his equipment than when cave diving. The cave environment (ceilings and walls) precludes the possibility of making an emergency ascent directly to the surface. A problem—any problem—must be resolved by the dive team inside the cave before it can exit. Cave divers must anticipate and plan for every possible contingency.

As a cavern diver, you share some of these same concerns. Although your penetration is limited to the direct-sunlight zone of the cave, the cave ceiling still blocks a direct ascent to the surface. The possibility of an accident occurring is increased if a light should fail in a far recess of the cavern without your having a spare, or if you become tangled in the guideline without a knife. Similarly, should your regulator fail, air sharing during the exit from the cavern will be more difficult if your buddy does not have an additional second stage on his regulator. Even with the proper equipment, problems may develop if your gear is allowed to dangle away from your body and become caught in the guideline. This chapter describes the dive gear necessary for safe cavern diving. It also provides suggestions on how to select cavern-diving gear, and how to wear the gear so that you are properly streamlined and therefore less likely to become caught in the guideline.

If you are a well-equipped open-water diver, you probably already own most of the dive gear you will need for cavern diving, with the exception of the cavern-diving reel. However, you may need to make some minor modifications to this gear to make it more suitable for cavern diving and, as you will learn later, change the way you use this gear.

Most commercially manufactured dive gear is generally reliable when new. Whether or not it remains that way depends for the most part on the way you maintain it. It is no accident that those who are most careful toward their gear, who inspect it prior

to each dive and when necessary have it repaired by qualified individuals, have the least equipment failures. Inspect your gear carefully before every cavern dive.

Regardless of the care you give your equipment, you can never completely eliminate the possibility of a failure. While the failure of some gear is a mere nuisance, the failure of a regulator or dive light during a cavern dive is potentially life threatening. For such critical pieces of gear you need a spare. Cave divers have customized a term to describe this duplication of key items: **redundancy**. As cavern divers, your redundant gear includes an octopus second stage and at least one spare dive light per diver. The more ambitious the dive, the longer the list of redundant equipment.

A final important, gear-related concept for cavern diving is streamlining. If you were to swim through a cavern as so many open-water divers do—submersible pressure gauge dangling beside you and inflator hose floating above your head—you would almost immediately become tangled in the guideline. Sometimes it seems as if the guideline is just waiting for you to get close enough for it to reach out and grab your gear. Irregular rock surfaces also easily snag stray hoses and other equipment. Thus, it is important to streamline your gear by wearing it so that it lies close to your body where it will not easily become entangled.

Mask and Fins. Your diving mask should fit well and be free of leaks. You have enough to do holding a dive light, running the guideline, and controlling buoyancy without having to clear your mask every few seconds. Many cavern divers prefer low-volume masks because they are less likely to get dislodged by the current found in some high-outflow springs. Almost any type of normal-sized power fin used for open-water diving is suitable for

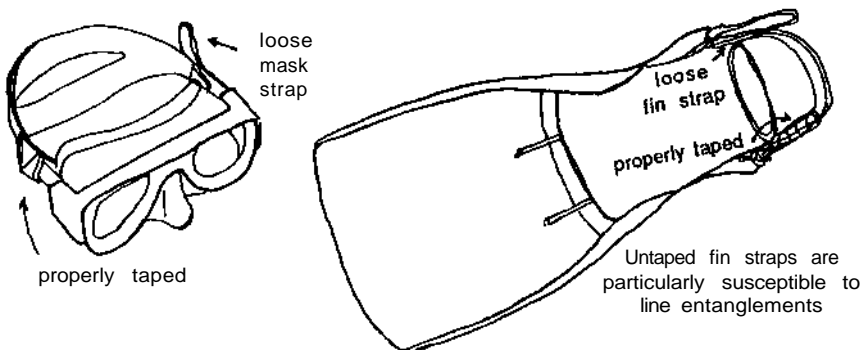

cavern diving. However, most cavern divers do prefer the open-heel, adjustable type of fin. Besides the easy adjustment, this type of fin allows you to wear wetsuit booties, making the walk to the water much more comfortable and keeping your feet warmer during the dive.

Whichever type of mask or fins you use, take care to adjust the straps for maximum comfort and security. Once they are properly adjusted, reverse the straps so that the tails lie inside the strap and then tape the straps in place with duct tape. These simple modifications insure that the straps will not slip during the dive, and will also minimize the chance of your getting tangled in the guideline. Straps should be inspected frequently for evidence of wear and other deterioration.

Snorkel. Streamlining considerations dictate that you should not use a snorkel while cavern diving. Few if any caverns contain natural air pockets where you might use a snorkel in an emergency. The only air pockets you are likely to find are accumulations of divers' exhaust air, which is unsafe to breathe. Snorkels pose a major entanglement hazard, while providing no real benefit, and therefore should not be used when cavern diving. Should snorkels be used for the open-water swim to the cavern, they should be removed and secured



outside the cavern entrance for the return swim to the beach or boat.

Wetsuits and Drysuits. Even though many caverns are spring-fed and as such, may feel warm, you will be more comfortable and will, consequently, perform better during the dive if you use a good quality dive suit. A hood is another sound investment; it not only insulates your head, a high heat-loss area, but also prevents cave sand from getting into your hair. Additionally, if you wear the hood over your mask strap, it also provides added insurance against the loss of your mask should the strap break or slip.

Weight Belt. A weight belt and weights are necessary to offset the positive buoyancy of the dive suit, and a buoyancy compensator, to restore the buoyancy lost through suit compression at depth.

Cavern diving demands more precise buoyancy control than open-water diving. Because you are in an enclosed environment, it is not enough simply to be neutrally buoyant. The cavern diver must assume a slightly head-down, feet-up profile. This helps keep fin blast directed away from the floor where it can stir up silt. This combination of proper buoyancy control and profile is called trim.

During the initial scuba course, the student is taught to wear the weight belt around the waist, that the weight belt is the last piece of equipment to be donned before entering the water, and that it is the first piece of equipment to be ditched in the event of an emergency. While this is an excellent axiom for open-water diving, there are several reasons why it is undesirable for cavern diving.

First, the cavern diver is exploring in an overhead environment; thus, ditching his weights during the dive can provide no positive benefit for his safety. Indeed, in some instances the diver may find that ditching his weights can actually pin him against the ceiling. Second, wearing weights around the waist will result in shifting the center of gravity low on the diver's body, often forcing him to struggle through the cavern in a feet-down, head-up position. To avoid this problem, trained cavern divers will modify the location and amount of weight carried during a cavern dive.

Recalling that a dive suit will compress during descent, it is logical to conclude that less weight is required to remain neutral at depth than to descend to that depth. And in fact, if weighted properly, it turns out that a diver needs only about 2/3's to 3/4's of the weight carried on his weight belt, in order to stay neutral. The other 1/3 to 1/4 of the weight is required only during descent. Once a few feet of depth are attained, this extra weight becomes little more than excess baggage.

Clever cavern divers have devised a means of eliminating this excess baggage by converting it to a "drop weight," a bundle of weights held together by a plastic cable tie or tape and attached to the diver with a quick-release clip. After the diver has descended a few feet, and prior to entering the cavern, the drop weight

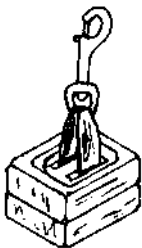

Typical drop weights



is removed and clipped to the guideline for ease in locating it during the exit. The remaining weights can be distributed across the diver's body to achieve the desired trim effect. Some of this weight may remain on the weight belt, while some is attached to the tank or tank harness—the end result being proper trim and maximum comfort for the cavern diver.

Buoyancy Compensator. Power-assisted buoyancy compensators, or BC's, are necessary to restore the buoyancy lost through suit compression at depth. Early on, even before the first commercial BC's were introduced, cavern divers used jerry cans and plastic jugs with the tops cut off to or from which they added or dumped air, as makeshift buoyancy-compensating devices to help keep them neutral underwater. Since then various cavern divers have successfully adapted all major types of BC's: horse-collar, jacket, open-shoulder style, and backmounted. The key to adaptation is fit. Most BC's include adjustable straps to accommodate individual divers. Use these straps to make sure that the BC remains close to your body and cannot float away. Have your buddy observe your profile while in the water. If your BC floats up or away then tightening of the straps or the use of a crotch strap is indicated.

Whichever type of BC you use, you need to inspect it periodically for bladder leaks, and to check to see that the

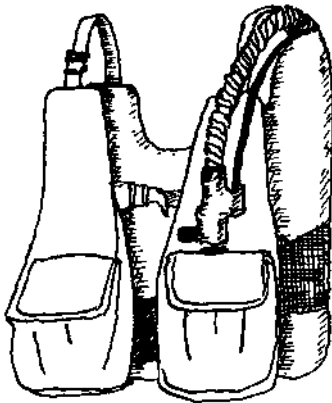

Open-shoulder style

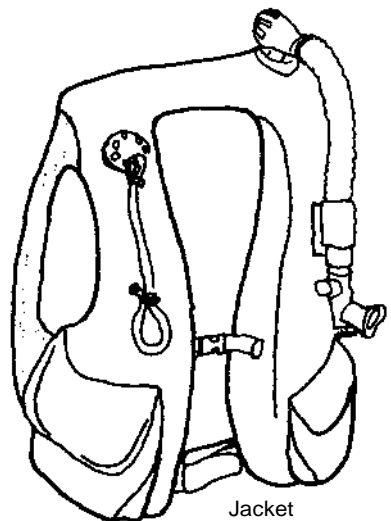

Jacket

overpressure vent valve and inflator are working properly. If your BC is equipped with a carbon-dioxide inflator, remove the CO2 cartridge and replace it with a spent cartridge or regulator port plug to prevent accidental inflation, which may pin you against the ceiling.

Next to the invention of the BC itself, the second greatest boon to trim control was the invention of the power-assisted inflator. The very first crude power inflator was invented and manufactured by a cave diver. The power inflator is an invaluable device for cavern diving since it allows you to inflate your BC using only one hand and without having to remove your regulator from your mouth. Whichever type of BC you use, be sure that you can easily locate the inflate and deflate controls.

Do not allow your BC hose to float above your head where it may become caught in the guideline. You can prevent this by connecting an elastic cord between the end of the BC hose and your tank harness, or directly to the BC. If you use a power inflator that connects to the end of the BC hose you can run the inflator hose beneath your arm and the BC hose above your arm, thus preventing the BC hose from floating upward.

Watch, Depth Gauge, and Dive Tables. You need a watch, depth gauge and dive tables to assure that you stay within the no-decompression dive limits. Though it is only absolutely essential that one diver in the team have these items, it is best that all divers be so equipped, particularly since it is easy for one of you to forget to set the watch bezel, or to have a watch fail during the dive.

Finally, you need to be sure that your depth gauge is accurate and therefore should check its accuracy at frequent intervals, particularly if it has been subjected to rough handling. The best way to check your depth gauge is to compare it with a calibrated gauge. Since few divers have access to such a service, gauges should be checked to see that they track smoothly during ascent and descent and that they compare with readings taken from other gauges at various depths. If there are significant discrepancies then the gauge should be returned to the manufacturer for repair and recalibration.

Compass. A common question posed by neophyte cavern divers is, "Why carry a compass if you always use a guideline?" The compass and "cave referencing" are two highly important navigational aids that go hand in hand with each other and the

guideline. Neither, however, should ever be substituted for the guideline. The compass will give you a general indication of direction, and cave referencing—looking over your shoulder from time to time as you swim in—will give you an idea of what the configuration of the cavern should look like as you swim out. Caverns frequently look a lot different on the way out than they did on the way in. If you should ever have a question as to whether the line is actually taking you out of the cavern, your compass and cave referencing should help reassure you.

Dive Knife. A knife is an essential piece of safety equipment used primarily to cut guidelines, free entanglements, and repair damaged lines. Since the knife is used to cut guidelines, a small sharp knife mounted on the forearm where it is easy to reach is more valuable than a larger knife worn on the leg. If you already use a large knife then it should be worn where it will not easily get tangled. Wearing the knife inside a custom suit pocket designed to hold it is preferable. Alternative sites include the BC hose, tank waist strap, or shoulder. The outside of your leg is the least desirable location for your knife. Some divers prefer to carry two knives which are mounted so that they can reach one with either hand in the event that the other is occupied.

Air Supply. While most divers use either a single 71.2- or 80-cubic-foot tank, cavern divers have used most all types and sizes of tanks successfully. For reasons which will become clear later, it is best that all dive team members use the same size scuba cylinder and that all the cylinders are filled to approximately the same air pressure (but not less than 2000 psig prior to beginning a dive). By following the above recommendations, air planning for the dive is considerably simplified.

Diving cylinders are usually fitted either with a K-valve, which has no reserve, or a J-valve, which maintains a small reserve air supply. However, the amount of air reserve provided by a J-valve is inadequate for safe cavern diving. Instead you should rely on your pressure gauge to make sure that you have sufficient air to safely exit the cavern and to deal with any emergency that may develop. If you are equipped with a J-valve, then the valve should be placed in the activated position, not the reserve position. Some care is necessary to insure that the J-valve mechanism is secured to avoid creating a potential line trap. Most cavern divers find that duct tape wrapped around the valve is adequate. The J-valve pull rod should be removed and stowed on

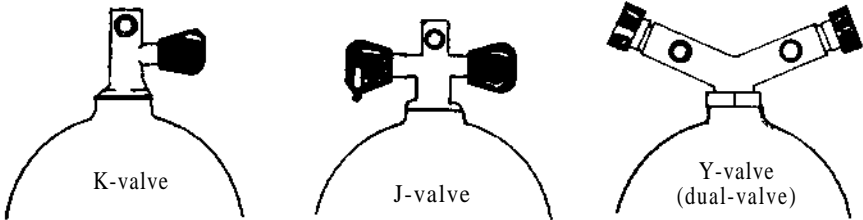

shore to avoid another potential line trap.

Although not required for cavern diving, many cavern divers consider the dual-valve manifold to be an even better alternative than either a K- or J-valve. Dual-valve manifolds are available for either single or double tanks. They provide two independent air outlets which allow two separate regulators to be attached to the valve. Should one regulator fail, it can be shut off leaving the entire remaining air supply available through the other. These manifolds are generally preferred over using two separate tanks, each with its own regulator; dual tanks with a single regulator outlet; or two tanks joined with a temporary yoke. Dual-valve manifolds should never be used with only one regulator attached since the other outlet may accidentally be bumped open.

Periodically check your cylinder-valve O-ring for damage or nicks, check the O-ring between the valve and tank neck for possible extrusion, and inspect the burst-disc port and valve handle for leaks. All cylinder-valve leaks must be fixed immediately since a serious failure will result in a rapid and uncontrolled loss of air.

Regulator, Octopus Second Stage, and Submersible Pressure Gauge. A single-hose regulator equipped with an additional second stage, submersible pressure gauge, and BC auto-inflator hose, has become standard for sport diving and is essential for safe cavern diving.

If you use a dual-valve manifold, one regulator should be fitted with the submersible pressure gauge and the other with the BC power-inflator hose. Thus, if one regulator fails, you would lose only one, and not both, of these accessories.

The way you wear your regulators depends on which one you intend to give away in an out-of-air emergency and whether or not you elect to use a long second-stage hose. Many cavern divers

prefer to equip their octopus second stages with a 5-foot- or even 7-foot-long intermediate-pressure hose. These longer hose lengths make it much easier to share air during an emergency exit from a cavern.

There are two schools of thought concerning which regulator you should give away to a buddy in need of air. There are advantages and disadvantages to both. Ultimately the decision as to which regulator you pass off should depend on which approach you and your buddy feel most comfortable with. The important thing is that the entire dive team understands which system is being used by whom, and is practiced in the procedure.

Those who favor passing off the regulator from the mouth contend that their buddies can find it there most easily and that the donor can more easily find his own other second stage. The primary disadvantage with this method is that it puts both divers temporarily out of air at the same time. Those in favor of passing off the octopus reason that their system prevents both divers from being out of air at the same time. The disadvantage with this system is that the octopus unit may be exposed to debris which could interfere with its operation.

Regardless of the type of air-sharing system used, the octopus second stage needs to be secured in a manner that will provide greatest accessibility and protection from silt. You should not keep the octopus in a pocket, or allow it to dangle where it can get caught or drag through silt. The octopus should be secured somewhere between the diver's shoulder and neck by an elastic octopus retaining strap around the mouthpiece. A safety plug can be used but has the disadvantage of sometimes requiring two hands to free the mouthpiece.

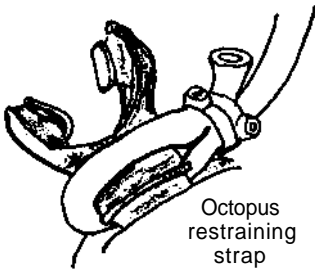

Octopus
restraining
strap

If you will be donating the regulator in your mouth and you are using a long hose, the preferred method of securing this hose is to route it under your right arm and around your neck. The coiled 5- or 7-foot hose must lie above all other hoses so that it won't get caught on the other hoses when you give it away. You simply bow your head to allow the long hose to unwind and make its full length available to your buddy. If you are not breathing

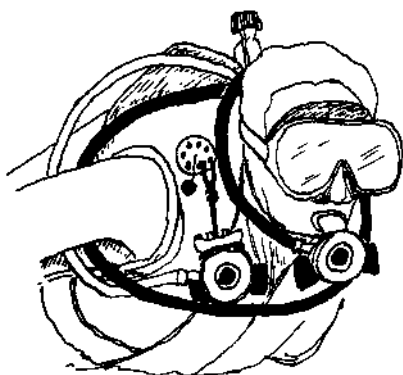

Long hose wrapped under right arm and around neck - must lie on top of all other hoses

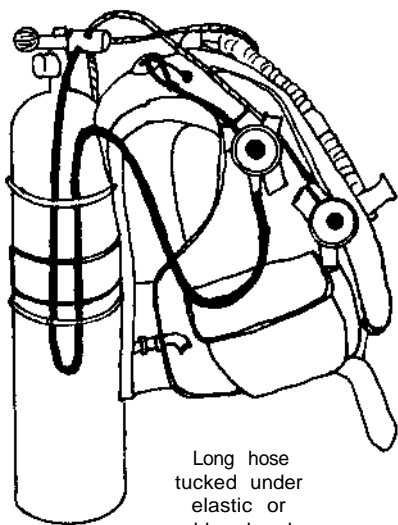

Long hose tucked under elastic or rubber bands

from the regulator you are passing off and it has a long hose, the excess hose is generally stored in one of two ways. It is either held in place by an elastic strap attached to the tank valve or it is routed along the side of the tank and secured with an elastic band; the second stage is then routed under the right arm and secured on the shoulder with an octopus retaining strap.

You must also insure that your submersible pressure gauge is not allowed to hang free. Many cavern divers prefer to attach this gauge to their wrists with a strap. Another method is to tuck the pressure gauge under your shoulder strap, or through the collar of a jacket- or horse-collar-type buoyancy compensator. The important thing is that you can easily read the gauge and that it rides close to your body.

Dive Lights. It is an axiom among dry cavers as well as cave divers that you should always have at least three reliable sources of light. For cavern diving these three sources of light are two underwater lights and the light from the cavern entrance.

Your primary source of light during a cavern dive is the sun. It is important that you stay within sight of the direct sunlight coming from the entrance at all times during the dive. If you move

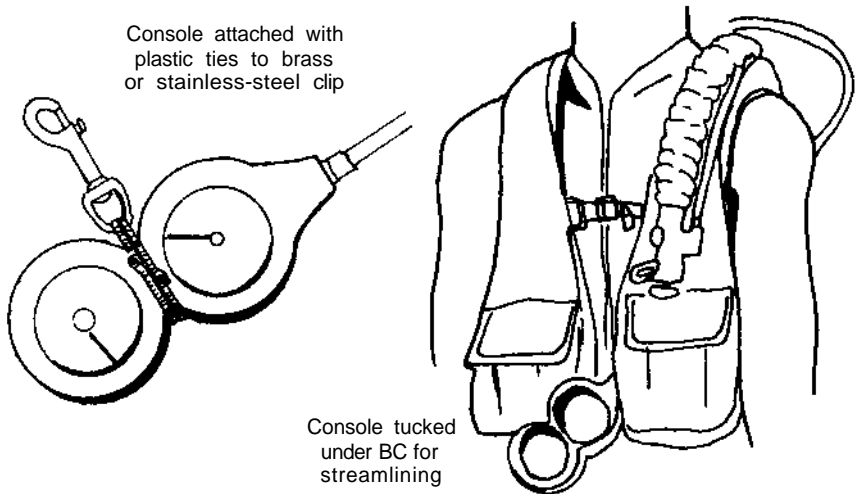

beyond the cavern zone of direct sunlight to where you can only see "ambient" surface light reflected against the cavern walls, floor or ceiling, or reflected against suspended particles in the water, you have entered the transition area to that portion of the cave where no surface light at all is visible. At any point past the cavern zone of direct sunlight you are beyond the level of cavern-diver training that this book addresses.

If, while using a hand-held light, you swim beyond direct sunlight into the ambient-light zone, you may not even be able to see the entrance glow unless you shield your hand light and let your eyes accustom themselves to the lower light level. Because you're busy exploring with the hand light, it is very easy to inadvertently swim out of the ambient-light zone and into total darkness without realizing it. Then when you turn around you are unpleasantly surprised to find that you have no reference whatsoever to the exit other than your guideline. Just a few feet—or a few inches—one way or the other can make all the difference.

Although you are going to be relying on sunlight as your primary light source, you will want to carry at least two battery-powered lights in order to view the fine details of the cavern, monitor your gauges, and signal your buddy. Why two lights? Because dive lights are the least reliable pieces of diving equipment.

Bulbs burn out unpredictably; switches break; batteries fail

either because they are not fully charged or have reached the end of their useful life; and lights flood, leading to corrosion and intermittent failures. It is not enough to check that your light works prior to a dive. You must be sure that the light is fully charged and that the batteries have sufficient power to last the entire dive. Rechargeable lights should therefore be charged before each dive, and non-rechargeable batteries, replaced before the light beam begins to grow noticeably dim. If a light floods, it should be carefully repaired and tested to insure there are no leaks before using it in a cavern.

Many experienced cavern divers carry additional lights so that in the event of a light failure, the dive need not be terminated prematurely. However, if you are using the minimum of two lights and one fails, the dive must be terminated and the team must exit.

There are a variety of lights available with different bulb intensities. As a general rule, each light should have a burn time equal to at least the entire planned length of the dive. It is also desirable for all members of the team to use lights of approximately the same intensity. Should one diver have a light that is much brighter than the lights of the other team members, it will be much more difficult for him to monitor their lights and see their signals.

You need to attach your secondary lights to your harness in a streamlined fashion. These lights should not be allowed to hang below your body or float above you. Generally, it is easiest to attach a clip to your light with a hose clamp or plastic cable tie and to clip the light to your weight belt, tank harness or a D-ring mounted on your tank. It is a good idea to follow this same



Several different approaches to securing back-up lights to brass or stainless-steel clips using plastic ties

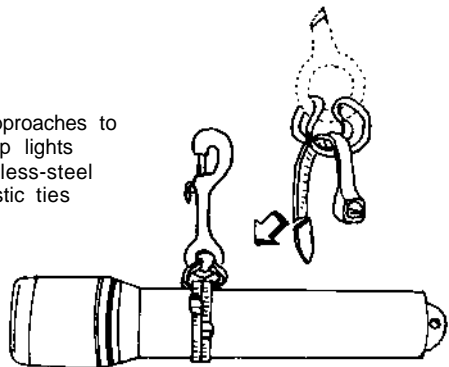

procedure with all your lights as it is often convenient to be able to clip them off at some point during the dive. Hand lanyards, which can allow a dive light to dangle several inches below the diver, pose an entanglement hazard and are therefore discouraged.

One final consideration regarding dive lights is a comparison between rechargeable and nonrechargeable batteries for cavern diving. Many divers use rechargeable batteries for open-water diving exclusively because these batteries offer high-output voltage and amperage characteristics. This is not only desirable but cost effective as well. Most of the rechargeable batteries on the market today are dry ni-cad cells. Although this is not intended as a chemistry lesson, discussion of some significant characteristics of this type of battery is warranted.

When properly maintained and charged according to the manufacturers' instructions, ni-cads provide excellent service if used frequently. This involves a series of full discharges and recharges, called cycles. If a ni-cad battery is not fully cycled on a frequent basis the battery may begin to develop a memory. In other words, the battery will begin to remember that it has not been fully discharged. When charged in this condition the battery will not provide a full burn cycle, and it will burn for shorter and shorter periods. The result can be a light which appears completely normal yet will operate for only a short time before failing. This failure frequency can, in many instances, be completely unpredictable. Other types of rechargeable batteries, like gel cells and maintenance-free batteries, do not have the memory characteristics of ni-cads, but generally are unavailable for smaller-bodied lights.

Nonrechargeable batteries are available in two general categories, alkaline and lead-acid. Alkalines are gaining popularity for their very constant high-energy output. For the cavern diver this results in a light with a very consistent, high-capacity light output, until the battery begins to reach the end of its usable life. Then the light bulb will begin to turn from a bright, white-colored light to a dull orange. As the light output begins to drop, the time between a color change and total battery failure can be very short. Lead-acid batteries provide a very constant discharge rate. Thus the light output of the bulb will never be as great as it was when initially activated. Divers are able to predict, with limited accuracy, the effective burn time of the bulb by its output color. However, should a lead-acid light

flood, the resultant battery leak may cause irreparable damage. Few experienced cavern divers allow all lights to be powered by one type of battery. While many choose ni-cads for one of their lights, other lights will be powered by either alkaline or lead-acid batteries.

Line. A cavern diver must always maintain a single continuous guideline to open water outside the cave entrance. In the event of a total light failure or complete siltout, the continuous guideline to open water outside the cavern will become your most important piece of safety equipment. Under those circumstances it can be your only link to the surface.

Since the line is used only as a guide out of the cavern and is not meant to be pulled on, lines larger than 1/16 to 1/8 inch in diameter are not necessary and are generally too bulky to be used. White nylon line is best since it is readily visible, retains its strength in water, does not rot, and does not float. Some cavern divers prefer braided nylon line over twisted nylon line because braided line is somewhat more abrasion resistant. Whichever kind of nylon line you use, it should be unreeled periodically and checked for abrasion.

In the past people have attempted to use other kinds of line for cavern diving, with unsatisfactory results. Polypropylene line, such as water-skiing tow rope, will float to the ceiling of the cavern, which makes following the line very hazardous. It can also move away from the diver and resist normal line-placement techniques. Manilla hemp ropes, such as clothesline and twine, not only float, but rot and are easily broken. Fishing line is much too small in diameter and under certain conditions may be impossible to see, presenting a severe entanglement hazard. Nylon parachute cord is also not a viable alternative because it is extremely difficult to cut, and this could pose a serious problem during a line entanglement.

Reel. In order to safely deploy, retrieve, and control the line during the dive, it must be stored on a reel expressly designed for this purpose.

Cave divers generally classify reels by the amount of line they are capable of holding. Exploration reels are usually larger physically than the others and are capable of easily retaining 400 to 800 feet of nylon line. The safety or gap reel, containing approximately 50 feet of line, is used by cave divers to fill the gap which may exist between two independent lines within the cave or

Three Different Styles of Reels for Cavern Diving

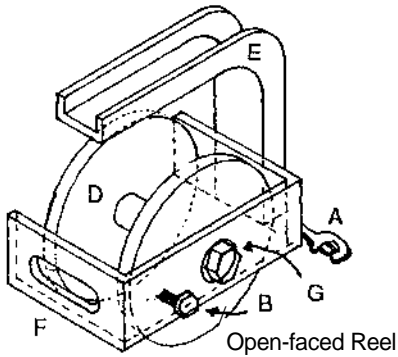

Cavern Reels are available in a variety of styles and sizes

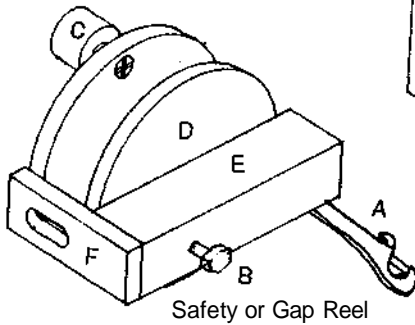
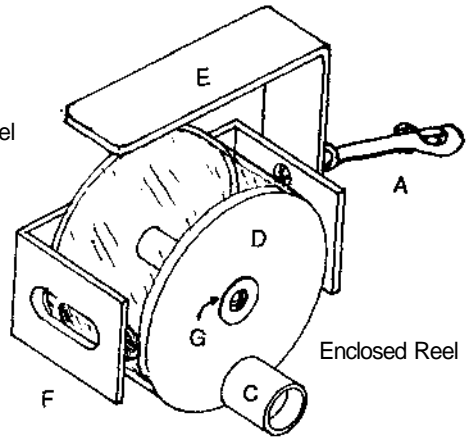

- A - Stainless-steel or brass snap to attach reel to diver for the swim to and from the cavern entrance.
- B - Lockdown screw used only when securing the spool from unwinding. The lockdown nut should never be used as a brake.
- C - Winding knob.
- D - Spool. Your index finger gently placed against the spool will act as a brake when deploying line.
- E - Handle. Designed to allow both the reel and dive light to be held by one hand.
- F - Guide. Guides the line back into the spool during retrieval.
- G - Hub. Holds the spool to the reel body yet allows for free movement of the spool.

to repair broken line. Cavern reels were developed specifically for the cavern diver. They are built like the exploration reel, but are smaller in scale, and designed to hold approximately 140 to 150 feet of line.

A reel has several key components: the handle, the line spool, the line guide, the winding knob, the lockdown nut, and the clip. The handle design of the reel is important since it determines how easy it is to hold both the dive light and the reel in one hand. You need to be able to do this so that you can use your other hand to adjust your buoyancy or reel in the guideline. You should be able to hold your reel and any of your lights in one hand so the light beam illuminates the cavern, whether you are playing out or reeling in the guideline. A proper cavern reel has a line guide that helps direct the line onto the spool in a neat and orderly fashion. It should also have a winding knob that is large enough to hold comfortably, and a lockdown nut to prevent the reel from spooling when not in use. The lockdown nut should not be used as a brake. All reels should have clips to clip the reel off conveniently when you're swimming to and from the cavern. The use of the reel is covered in more detail in a later chapter.

Gearing up for the Dive. Have you ever noticed how some divers seem to take forever to get geared up for a dive, leaving their buddies who are ready to start the dive, to boil in the sun? When divers are slow in gearing up it is because they have not organized their gear and have no system for getting ready. Once you find a system that suits you, not only will you get geared up more quickly with less effort, but you will have an opportunity to check your gear more carefully before the dive.

First you need to store all your gear in one location. It is not so important what you store the gear in—dive bag, tub, or box—but rather that it is all together. If you are diving from a sandy area it is a good idea to have some kind of tarp or ground mat to keep your gear from getting dirty.

As you unpack your equipment, carefully check each item. Check your mask and fin straps for signs of deterioration, and give a pull to see that they are secure. Get out your cavern reel and check it for obvious damage, ease of operation, and condition of the line and quick-release clips. Take out your dive lights and check them for signs of leakage; see that all O-rings are seated properly and that all lights work. Make sure the clips are in good condition.

Take out your slate, check any notations you have made on it, and erase those you no longer need. Be sure the pencil lead is sharp. Remove your knife, check it for deterioration, and insure that the sheath straps are in good condition. Make sure your depth-gauge needle is on zero and that the strap is in good condition. Examine your dive watch to insure that it's working properly and check the strap. When you get to the BC, check its harness for tears, inflate it, and check for leaks. Remove your wetsuit, wetsuit boots, and hood if you use one. Check and clean their zippers and lubricate them if necessary. Now imagine yourself gearing up. As you put on each piece of equipment in your mind's eye, look at the pile of equipment and make sure it's there.

Next get out your tank. Carefully inspect the valve handle and burst disc for leaks, and the tank O-ring for signs of extrusion. Clean the regulator O-ring and check it for nicks or cracks. If damaged, replace this O-ring now. Attach your regulator to the tank valve and inspect it for obvious external damage. Before turning your air on, check the mouthpieces and try inhaling through the second stages. Do the exhaust valves leak? Check all hoses for damage and make sure the submersible-pressure-gauge needle is on zero. Next turn the air on slowly. Check the cylinder pressure, but be sure not to look directly at the gauge when turning on the air since a leak may cause the glass to burst. After you have turned on the air, check the valve and regulator O-ring for leaks. Breathe from both second stages and make sure that neither is free flowing.

Having done all of the above and corrected any problems, check to see how your buddy is coming along and examine his equipment. Bring any potential problems to his attention, and ask him to do the same for you. If you are both at about the same stage of preparation you can now consider getting into your wetsuit. If not, then wait; no sense in roasting by suiting up too soon. Once you have donned your wetsuit, put on the rest of your gear in a definite sequence. Check each piece again as you put it on. After you have finished the dive you can essentially reverse the procedure without the gear checks to pack up your gear.

Chapter 5

Buoyancy Control and Propulsion Techniques

The first and most important skill you will need to master to become a proficient cavern diver is to move through the cavern easily without causing silting. If you can do this well, then all the other tasks you will need to perform, such as running the guideline, monitoring your air supply, and keeping track of your buddies, will be made easier. To move through the cavern efficiently you will need to learn how to maintain a level trim while underwater and to use specialized propulsion techniques that minimize silting.

You are in a level trim when you can, at rest, hold a horizontal position in the water without having to use your hands or feet to remain stable. You should rise slightly with each inspiration and sink slightly with each expiration. Maintaining a level trim requires that your equipment be set up properly, and that you can achieve and maintain neutral buoyancy easily using your buoyancy compensator.

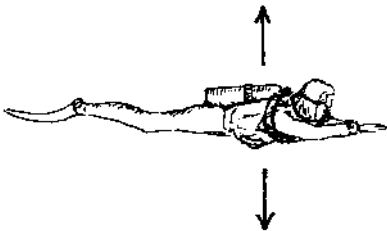

The diver's buoyant force and weight force are balanced over each other so that, at rest, he is level horizontally

To understand how these two factors, equipment set-up and buoyancy compensation, relate to achieving a level trim underwater requires an understanding of those factors that affect a diver's buoyancy underwater. When you enter the water, you and

your equipment create a buoyant force equal to the weight of the volume of water displaced. Similarly, there exists another force, a weight force, or gravity, that tries to make you sink. Your net buoyancy is determined by the balance between these two forces. When your buoyant force exceeds your weight force then you are positively buoyant and you rise or float. If on the other hand, your weight force exceeds your buoyant force, you are negatively buoyant and you sink.

Since the human body is nearly neutral in water, most of your buoyant force comes from your dive suit and buoyancy compensator, while your weight force is contributed to by the lead weights you need to wear to offset the buoyancy created by the dive suit at the surface, and the other equipment you need for the dive. However, as you descend, increasing pressure compresses your dive suit causing it to lose buoyancy. If you started the dive neutrally buoyant, then to remain neutral at depth you will need to add air to your buoyancy compensator. As you ascend you will need to vent air from your BC to keep from becoming increasingly positive as the dive suit and BC expand. Thus, as you change depth during the dive, you will constantly need to add or vent air from your BC to remain neutral.

Sometimes it is difficult to sense when you are neutral underwater. Swimming tends to mask your true buoyancy since you tend to adjust your attitude in the water as you swim in order to move horizontally. For example, if you are negative while swimming, you will tend to assume a feet-down trim. In this position part of your fin thrust goes to moving you forward while another portion is used to offset your tendency to sink. Besides being inefficient by causing you to waste energy to keep from sinking, swimming in a feet-down attitude causes silting.

To sense your true buoyancy you need to remain motionless so that swimming motions won't mask it. If you tend to rise slightly with each normal inhalation, and sink with each normal exhalation, so that during normal breathing you do not change depth significantly, you are neutral. Later, as you gain skill, you will learn to adjust your buoyancy with precision so that you will only have to stop swimming occasionally to check it.

However, it is not enough to be able to achieve neutral buoyancy; you must also be able to maintain a level trim. You have probably noticed that when most divers stop swimming they tend to assume an upright attitude. This happens because most of

Overweighted or trimmed foot-heavy, the diver must use more of his energy swimming upward than forward

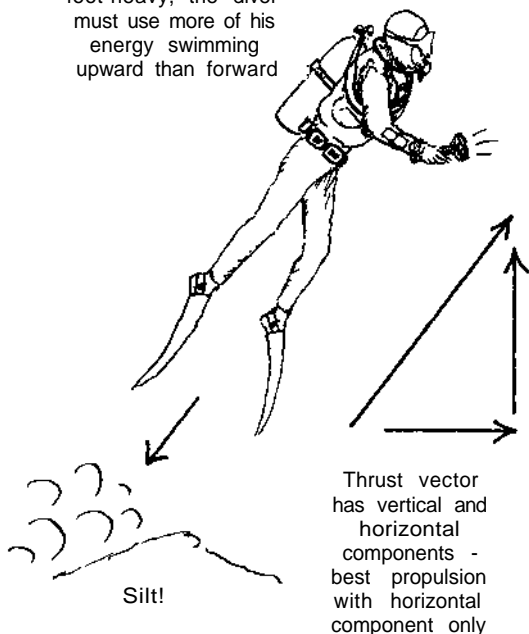

their buoyancy is centered up near their shoulders while most of their weight is centered lower on the body near their hips.

Even though they may be neutrally buoyant, when they stop swimming their hips tend to sink while their shoulders rise until they reach an upright attitude where their weight is directly below their buoyancy. From this position any fin motion whatsoever will cause silting. To avoid this tendency to turn upright when stopping, you will

need to lower your center of buoyancy and raise your center of gravity so that they are closer together. You do this by modifying your equipment to shift its buoyancy lower and by moving your lead weight higher.

Horse-Collar Vest. Horse-collar BC's are the oldest style of BC still in use. This design tends to concentrate a great deal of the vest's air in the neck region and, when the horse collar is nearly full and the diver is level, most of the buoyancy is below the diver's chest. This produces a tendency for the diver to assume a head-up attitude and also to roll him onto his back where the vest is higher than the tank. While this position is desirable in open-water diving, it is not desirable in a cavern.

To minimize these tendencies to roll out of position, you may need to wrap the neck of the vest with duct tape to reduce its volume as much as possible, while still allowing air to move through the neck so it can be vented. You should also keep the crotch and waist straps tight so the vest doesn't ride up.

Open-Shoulder-Style and Buoyancy-Control Jackets. These jackets tend to concentrate part of their buoyancy on your back near the tank and part laterally along your chest. As you change position in the water this buoyancy tends to shift. If you are upright, most of the buoyancy moves to the upper part of the jacket. When you are level, most of the buoyancy will be around your back, provided the vest is not over-inflated. Thus, by carefully assuming the trim that you want, you can shift your buoyancy where you want it.

Without a crotch strap, these jackets will ride upward on your chest like the horse-collar BC. The chest panels may also pull away laterally from the midline of your chest. If the jacket rides up then it will tend to float you upright, whereas a lateral shift of the side panels will tend to make you unstable sideways. Proper straps will reduce these tendencies.

Buoyancy-Control Wings. Buoyancy-control wings concentrate their lift around the scuba cylinder and above the diver, which helps to minimize the tendency to roll over onto one's back. In essence, most of the buoyancy is confined to two long tubes, one on each side of the scuba cylinder, with the vent near the top. This may produce a problem when a diver assumes a sharp head-down attitude. In this position most of the air is near the base of the wings, away from the normal dump valve. If you become too positive in this position, you will tend to rise, while at the same time you may be unable to vent the expanding air. You should be careful when taking a head-down trim, to be sure you are able to right yourself and vent the wings when necessary.

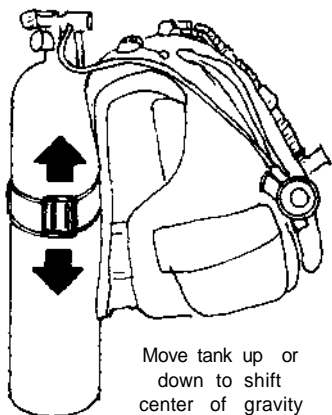

Weights. In addition to lowering your center of buoyancy by modifying the BC, you can also raise your center of gravity by moving your lead weight upward. When cavern diving you do not want to ditch your weights, otherwise the resulting uncontrolled positive buoyancy may pin you against the ceiling. Thus, a quick-release weight belt is not needed and you can attach your lead almost anywhere. To raise your center of gravity, attach your lead weights to your

backpack straps either at the waist, or on the shoulders if you need the weight higher. Alternatively, you can attach some of the lead directly to the tank or tank pack, shifting it up or down along the tank as needed to achieve a level trim. You may also move the tank itself up or down to raise or lower your center of gravity.

However you make these modifications, your goal is to produce an equipment arrangement that allows you to easily maintain a level trim in the water, without a tendency to roll over or turn upright. If you can lay horizontally in the water with your legs bent at the knees, fins pointing upward, without using your hands or feet to hold position, then you have taken the initial and most important step in learning to move through the cavern. From this ideal position you can now proceed to learn the specialized propulsion techniques that will minimize silting as you swim.

Propulsion Technique. Many different techniques have been developed to enable a diver to move through a cavern without silting. Sheck Exley, one of the world's most experienced cave divers, once described 37 different techniques for moving through an underwater cave. However, if you carefully analyze these techniques, you will find that they use similar approaches to solving the common problem of silting. Most of the techniques require the diver to be either neutral or slightly positive and in a level or slightly feet-up, head-down trim. From these trim positions, the diver can use a number of specialized kicks and hand techniques to move through the cavern. There are five basic propulsion techniques which, when combined with judicious use of the hands, will allow you to move through most caverns without silting. These are the modified flutter kick, the shuffle kick, the frog kick, the ceiling pushoff, and the pull-and-glide technique.

Modified Flutter Kick. During your initial open-water training you were taught to use a flutter kick. This kick emphasizes strong alternate fin strokes generated by a strong downward thrust of the thigh. Unfortunately, when the fin passes below the diver's midline a significant portion of its thrust is directed downward where, in a cavern, it can stir up silt. Thus, the standard flutter kick is unsuitable for cavern diving. Yet if modified slightly, it can be one of the easiest strokes for an open-water diver to master for use while cavern diving.

Unlike the flutter kick, the modified flutter kick gains its

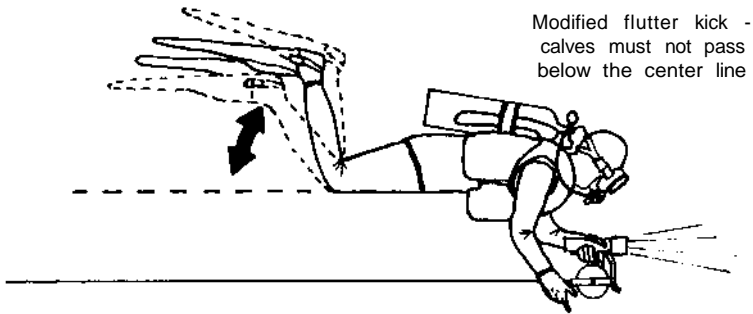

thrust from movement at the knee rather than the hip; the thigh remains horizontal. From a level trim, alternately bend and straighten each leg at the knee. This produces a more front-to-back rather than up-and-down movement of the fin. By extending the ankle slightly at the beginning of each fin stroke, the blade will catch more water and provide greater thrust.

Since the thigh is stationary and horizontal, straightening the leg cannot drive the fin below the diver's midline. When you are in horizontal trim, little fin thrust will be directed downward. If tilting conditions are very severe, you can shorten the power stroke, stopping it well before it reaches the horizontal.

Shuffle Kick. The shuffle kick is not too different from the modified flutter kick. With your thighs lying along your centerline, your knees bent sharply at 90 degrees so that your calves point toward the ceiling, and your ankles locked, rapidly bend and straighten your knees to produce short fin strokes of no more than 6 to 12 inches. When this kick is performed rapidly, it

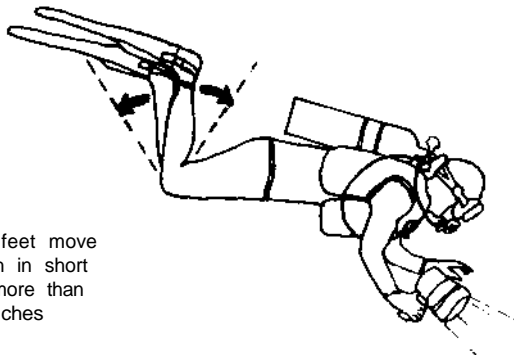

Shuffle kick - feet move
back and forth in short
shuffles no more than
6 to 12 inches

can generate sufficient thrust to keep you moving and in control. It is especially useful when swimming around fragile formations where even the modified flutter kick may cause silting or damage. Although the shuffle kick may initially feel tiring, with practice it will become comfortable and effective.

Frog Kick. The frog kick is useful for generating a great deal of power and thrust for entering high-flow springs (if hand holds are not available), and for moving through large cavern passages quickly. Because the frog kick requires the use of different muscles than either the modified flutter or shuffle kicks, switching over to it occasionally will prevent you from tiring as easily and your legs will be less likely to cramp.

The frog kick begins with your body in level trim, and your entire leg straight along the centerline. With your fins parallel to your body, your feet are separated as far as possible while still remaining comfortable. The power stroke is generated by bending your ankles and forcing your feet together, as if you were attempting to clap your feet like one would clap hands, then gliding until you lose most of your forward momentum.

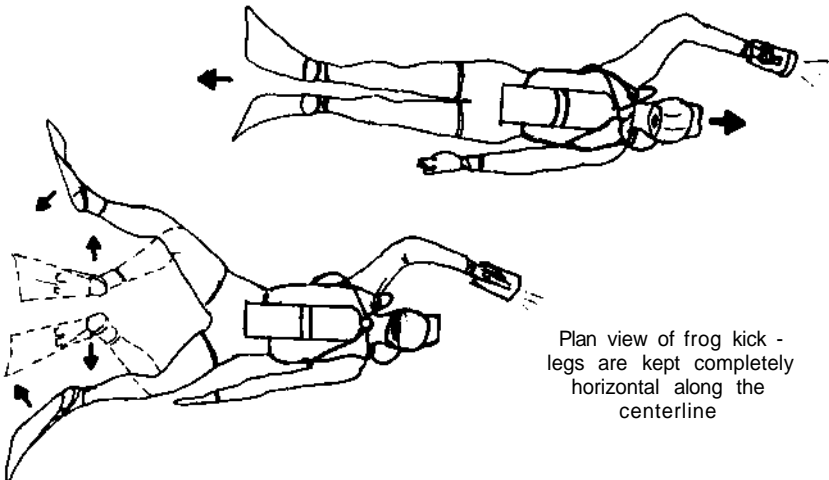

Plan view of frog kick - legs are kept completely horizontal along the centerline

Ceiling Pushoff. The ceiling pushoff is useful when the cavern ceiling is smooth and regular, and in very low passages where you want to be as near the ceiling as possible. Inflate your BC so you are slightly positive. If you are in a level trim with

your knees bent at 90 degrees, you will rise till the blades of your fins come to rest against the ceiling. From this position you can gently push yourself forward with the fin blades and heels. Do not push hard, however, since a vigorous push will tend to push you away from the ceiling and cause you to lose control. Instead, push yourself along smoothly and gently with short strokes. The ceiling pushoff should never be used if there are fragile formations on the ceiling that might be damaged.

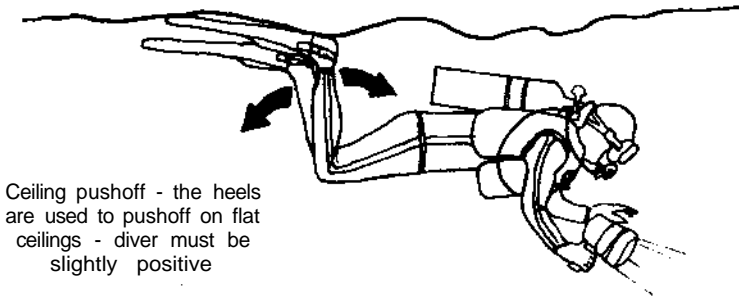

Ceiling pushoff - the heels are used to pushoff on flat ceilings - diver must be slightly positive

Pull-and-Glide Technique. When the cavern walls are irregular, and have numerous rock outcroppings along the walls and large rocks on the floor, you can use your hands to pull and glide through the cavern. Be careful not to pull too hard on small projections since most submerged rock is soft and may break off in your hand. Stalagmites and stalactites in heavily decorated caverns are particularly fragile and should never be touched.

If the handhold is firm, you can pull yourself forward, and when you pass the handhold, you can continue to push and glide until your momentum has dissipated. Such pull-and-glide techniques are extremely useful in avoiding silt and helping to reduce leg fatigue.

You can also use the natural handholds of the cavern to give you stability when stopping, signalling your buddy, or turning around to exit the cavern. Often as you move through the cavern you will have to stop to keep from running into other divers, to solve some minor problem, or to admire some feature. When stopping it can be difficult to arrest your forward momentum and still keep in control without causing some silting. To minimize this silting and to maintain an even trim, you should stop kicking, inflate your BC so you will tend to rise away from the cavern floor, and reach for a handhold that will allow you to remain stable

while stopping even in strong current.

If the cavern is small and no good handholds are available, it is sometimes better to carefully put a finger down on the cavern floor even if it has a heavy layer of silt. This will frequently cause less silting than the misdirected fin strokes of a diver out of control. You will minimize silting with this method if you use only one finger rather than your entire hand, or your hand rather than your light or reel.

Judicious use of the hands can be of great aid in implementing any of the kicking techniques described above or in stopping and turning. However, you should be careful of unnecessary and useless hand motions. Many divers unconsciously fin with their free hand. These finning motions provide little real forward thrust but can cause a surprising amount of silting. Constant hand finning is a symptom that the diver is out of proper trim; therefore, he will need more practice or possibly some equipment changes to achieve better trim control.

Used skillfully, these techniques can move you through almost any cavern without silting. After you have mastered each of the individual techniques in open water, you will need to learn how to put them together into a smooth, efficient means of propulsion.

Integrating Techniques. If you were to observe skilled cave divers on a cave dive, you would notice that not only do they perform each kick well, but that all the different techniques they use blend together, each diver changing technique based upon the particular demands of that particular cave passage. For example, as they enter a large cavern you would probably see them swimming in mid-water away from the floor and ceiling using a modified flutter or frog kick. Approaching a low passage, the divers might switch to a shuffle kick, and increase their buoyancy to rise closer to the cave ceiling. At times their fins might come to lie against the ceiling, resulting in their using the ceiling pushoff to keep moving steadily forward. Turning into another low-ceilinged passage with a rock-strewn floor and heavy current, they might pull-and-glide using the rocky handholds while simultaneously pushing off the ceiling with their fins. Thus, as experienced cave divers move through a cave, they constantly change techniques, employing them either singly or in combination to suit the demands of the particular passage.

Such sophistication can only come through practice and experience. Initially, you will want to gain good control of the basics in clear and large caverns. These dives will allow you not only to perfect your technique but also to practice reading the cavern. After these techniques become second nature, you will be comfortable enough to look ahead farther, analyzing the cavern's particular requirements in order to select the best propulsion technique.

You will learn to adjust your trim from level to slightly head-down depending on the nature of the cavern. For example, suppose a silt slope drops abruptly from 30 to 60 feet at a 45-degree angle. If you were to descend this slope with a level trim, your fin blast would cause considerable silting on the slope behind you. Instead, you would want to adopt a head-down attitude and, since you are descending, be ready to add air to your BC so you don't become too negative.

There are many other techniques not mentioned here that are useful in moving through caverns. The ones described above are the most universally applicable. You may, as your skill increases, wish to try others. Do so. But always remember, the primary purpose of these techniques is to move you through the cavern without causing silting and with the minimum of effort.

Chapter 6

Use of Lines and Reels

A safety line carried on a suitable lightweight line reel is, perhaps, the cavern diver's most essential piece of safety equipment. Even the brightest light cannot get a diver, lost in a maze of passages with visibility obliterated by stirred-up sediment, out of a cavern. A safety line can. The need for a safety line to insure a fail-safe route to the exit may seem obvious; however, accidents caused by the failure to use a safety line are the most common direct cause of underwater cave fatalities. Typically, a group of divers with no cavern-diving training will venture into a cavern completely unaware that they are silting up the passage behind them. When they turn around to exit, they discover, to their horror, that they cannot see which way to go. Unsure of the direction out, one or more of the divers swim into the clear water—farther into the cave—even though the silted passages trace the way to safety.

Using the guideline effectively requires teamwork and training. Each member of the team has specific responsibilities in insuring that the line is run properly through the cavern, that all team members can get to the guideline easily at all times in case of a problem, and that none of the divers becomes entangled in the line. How effective each team member is in accomplishing these tasks determines how efficiently the team can move through the cavern.

Proper line-laying technique is perhaps the most difficult cavern-diving skill to master. The dive leader runs the reel and has the responsibility of securing the line at the entrance, positioning it properly in the cavern, and reeling it back out. Because he is burdened with the responsibilities of the reel, the dive leader is usually the most task-loaded member of the team. However, as the team grows with experience, this load can be distributed more equitably throughout the group.

The team leader, who carries the reel, is always the first one to enter the cavern and the last to exit. All other team members must stay between him and the entrance to the cavern. Failure to do so could result in a diver becoming separated from the group and the guideline, which is the only fail-safe route to the exit.

The second diver assists the team leader by supplying light when needed and by helping to route the line so that it is well placed and does not wander about the cavern whenever the team leader changes direction. When exiting, the second diver is responsible for freeing the line from any anchors or obstacles, taking up any slack, and providing any other assistance to the reel man as needed.

Additional team members are responsible for keeping together, watching for and alerting the others of unsuspected silting, referencing their compasses and their location within the cavern, and being ready to help other team members if needed. Your team's effectiveness in doing these jobs will in part determine how safe and enjoyable the dive will be.

Securing the Guideline. Prior to entering the cavern, while still in open water with an unobstructed path of ascent to the surface, the line is initially secured. This is referred to as the primary tie-off. It is secured in this manner so that, in the event of an emergency, when you get back to the origin of your line, you need only inflate your BC for an unobstructed ascent to the surface. The guideline should then be secured a second time just inside the cavern entrance to prevent open-water divers or swimmers from disturbing it. This second anchor is referred to as the secondary tie-off.

You can anchor the line to sunken logs, boulders, or rock outcroppings along the walls. When using a sunken log or boulder as an anchor, be sure it is stable and cannot be pulled into the cavern, and that it is sturdy enough not to be broken by a sharp tug on the line. When you tie the line to these objects be sure you cannot easily pull the line off the end of the object.

When tying off to a rock outcropping, make sure that it is stable and will not break off when you pull on the line; submerged rock can be crumbly and surprisingly brittle. Sometimes you can find a rock ledge with a hole through it. These are ideal anchor points since, by passing the line through the hole, you cannot pull it free from the anchor unless the rock breaks. Whichever object you tie off to, once you have secured the line, pull on it from all

Bowline Knot - when tied properly, it forms a secure, non-slipping loop

The loop must be large enough to allow the reel to easily pass through

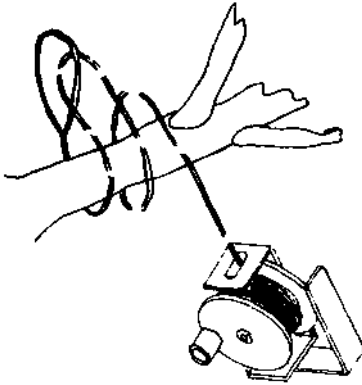
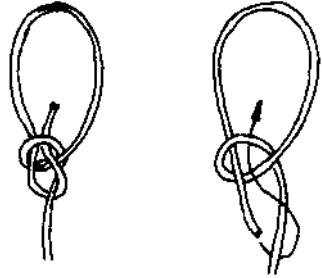

Primary Tie-off - with an unobstructed ascent to the surface - pass the reel through the loop and then make an additional wrap - pull in all directions to make sure the anchor is secure

Secondary Tie-off - just inside the cavern entrance the line is secured again as a safeguard against tampering by casual swimmers or other divers



Line Placement - the line is routed around a projection to keep it in place and prevent it from going into a line trap

directions to make sure that it is secure regardless of the direction of pull. Finally, never tie your line to another diver's line or onto the same object to which another line is tied, since the other divers may damage or loosen your line when they remove theirs.

Sometimes it may be difficult to find a secure anchor and to tie the line to it so that it cannot come free. Enterprising cavern divers have devised their own primary line tie-offs by bringing their own concrete blocks, extra weights, etc., which can serve as temporary anchors. These items are always removed from the dive site after the dive.

One of the easiest ways to secure the line to your anchor is with a loop pre-tied on the surface, which is large enough to pass your reel through. (The preferred knot for this loop is the bowline, because it is easy to tie and will not slip.) Underwater at the anchor you create a large "slipping loop" by wrapping the loop-end of the line around the anchor and then passing the reel through it. Or if the anchor allows, you can create your slipping loop first, then place it over the anchor and pull it snug. Make a few additional wraps of line around the anchor in the direction opposite the loop to keep the line tight.

Running the Line. Once the line has been anchored in open water and secured inside the entrance by making a few wraps around a second anchor, and after checking to make sure everyone is ready to continue, the team leader then begins to swim into the cavern normally, allowing the line to play out behind him. He must be careful to maintain tension on the line and to avoid sudden changes of direction that may drag the line into the other team members. The best way to maintain tension on the line is to apply a slight pressure with your index finger against the reel spool as you swim. If you do not maintain tension on the line, but allow the line to slacken, line may spill off the spool and the reel may jam.

When laying the line, hold both your light and reel in one hand so that your other hand is free to control your buoyancy, monitor your gauges, compass, etc. Hold the reel with the line guide facing the line so that the line can pay out freely. Hold the reel below you and slightly to the side so that you don't get fouled in the line. As you move through the cavern, you may find it necessary to pass the reel from one hand to the other as the passage changes or as handholds require. When passing the reel between hands, assume a head-down, feet-up trim to prevent your

The best way to maintain tension on the line is to apply a slight pressure with your index finger against the reel spool as you swim. If you do not maintain tension on the line, but allow the line to slacken, line may spill off the spool and the reel may jam.

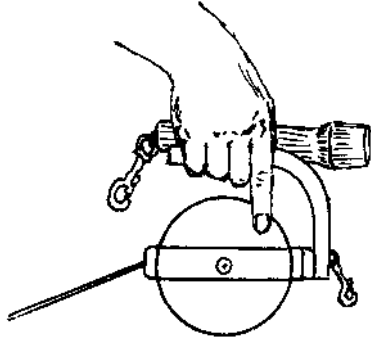

fins from getting caught in the line.

Dealing with Slack Line. Occasionally, even the best cavern divers will allow the line to become slack. If this happens on the way into the cavern, it's usually only momentary, and most frequently occurs when the lead diver switches directions. The easiest way of dealing with it is for the second diver to gently support the line with an open hand, preventing the line from getting entangled in anything until the slack is taken up by the reel man.

If it occurs on the way out, because the reel man is unable to retrieve the line fast enough to keep up with outflowing current, the second diver can hook the line on the forefingers of each hand and pull the line out to arm's length. This keeps the line taut and free of tangles while the reel man catches up. As the line is being reeled in, the second diver can bring his hands back together, keeping a little tension on the line. With this technique, neither diver need stop swimming.

If this technique can't accommodate all the slack line, the second diver should look for a rock outcropping around which to temporarily wrap the line. Then he can gently feed the line off to the reel man until the excess is retrieved. If slack line is not dealt with, the reel can jam or a diver can become entangled.

Line Placement. It is best to run the guideline so that a diver can easily swim above and to the side of it. From such a position a diver can more readily keep track of the line, since it is much easier to look down than up when following a line. You need

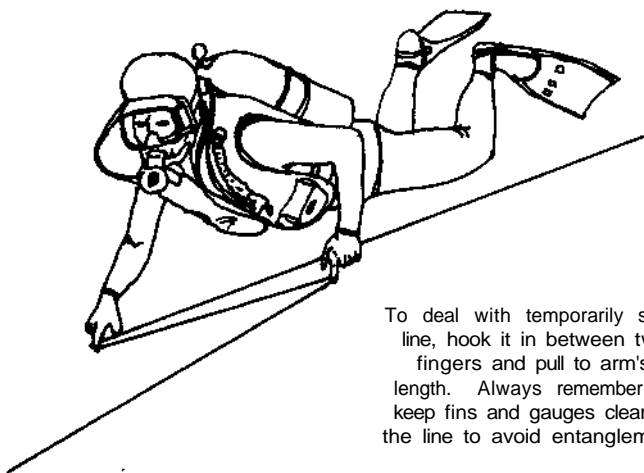

To deal with temporarily slack line, hook it in between two fingers and pull to arm's length. Always remember to keep fins and gauges clear of the line to avoid entanglement.

not hold onto the line at all times. However, always remain within arm's length of the line so that you can reach out and touch it at a moment's notice.

Never run the line along the ceiling if you can possibly avoid it. If you get entangled in such a line, you will be caught from above and behind where it is more difficult to get free. It is also extremely difficult to keep continuous track of a line run along a ceiling. Bending your head back to look up at the line is both uncomfortable and potentially hazardous, as it promotes silting by forcing you to assume a head-up, feet-down posture. Since you will be unable to keep track of such a line at all times, it is possible to inadvertently follow another line run nearby and become lost. Because of the possibility of accidentally following another line that's already in the cavern, you must use careful placement techniques to keep your line well apart from any other existing line. Never cross lines.

In smaller passages, you will need to run the line near the floor so that you can remain above it. Your hand should always remain on the line in these circumstances since silting is highly likely. Always be aware of potential line traps, places that the line can go but you can not follow.

Line Wraps. In the past lines were wrapped at frequent intervals around rock outcroppings to keep them in position.

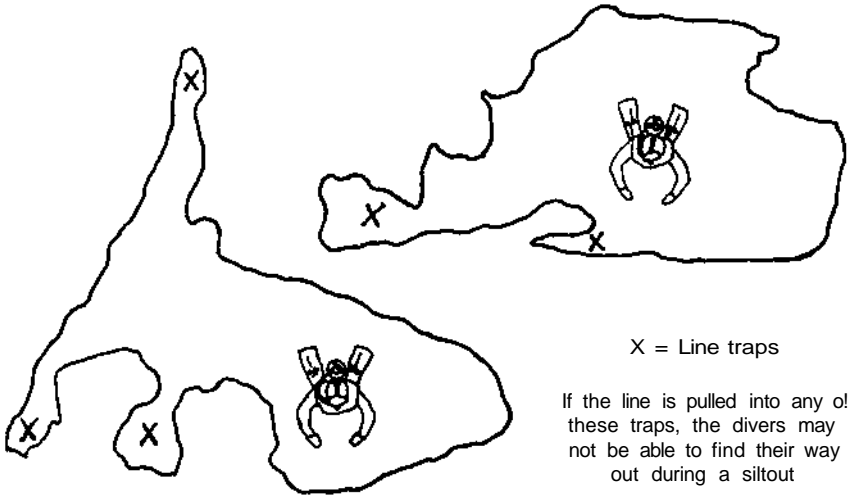

However, the use of line wraps has several disadvantages. When wraps come loose, or an outcropping breaks off, the line will become slack, particularly if multiple wraps were used. More important, however, is that lines with many wraps are more difficult to follow in reduced visibility. As a result, the NSS Cave Diving Section recommends that line wraps be used only where absolutely necessary to keep the line in position, and then to use only one turn around the rock. It is better to carefully route the line along uneven walls and around rock outcroppings without wraps, and allow friction to hold the line in place.



Line wrap around a small anchor - the twist makes it easier to follow in zero visibility

Experienced cavern divers often find that, other than the initial two tie-offs (outside the cavern and just inside the cavern), no other line wraps are required, only placements. The only exception might be to avoid a line trap. But in these

situations it is still better, if at all possible, to place the line in order to avoid the trap rather than wrapping it around a rock outcropping.

Exiting the Cavern. When exiting the cavern, hold the reel in front of you with the line guide facing towards the line. Reel in the line smoothly and steadily so that you can maintain some tension on the line at all times. This is important since your buddies will be ahead of you and will not be aware of any sudden movements of the line that you may cause. To keep the line out of the way of your buddies, move the reel from side to side or up and down as required.

It is frequently easier to reel in the line if you are slightly negative. At times you may have to stop in order to vent your buoyancy compensator or because other team members ahead of you have stopped. This is easier to do if you are slightly negative, and can slowly sink to the cavern floor. This action will arrest your forward motion and insure that you can keep tension on the line at all times.

Line Following. When following the team leader you need to know the position of the guideline at all times, but you do not necessarily have to be in direct contact with it all times. However, you must always remain within arm's length of the line.

You can best keep track of the line and reach it most quickly by remaining above and slightly to the side of it. Since it is easier to look down than up, you are more likely to know the location of the line by remaining above it. Moreover, at times during the dive the team leader may suddenly change direction and drag the line toward you. You are less likely to get caught in a wandering line if you stay above it. Finally, should you get caught in the line, you will be caught from below, usually in an area you can reach and free yourself.

As you explore the cavern it is likely that you will need to cross the guideline. Whenever possible, cross over the guideline, not under it. When crossing over the guideline, reach down and, with an open palm, push the line away from you. Keep your feet well up and check to be sure you do not have any gear dangling below you. When actually crossing the line, look at the line below you; if it moves when you swim over it you may have become entangled.

Sometimes it is difficult to tell if you are caught in the line. For example, as you swim along with the line snagged on a dangling

submersible pressure gauge, you may pull the line over a considerable distance before it stops your progress. If you suspect that you might be caught in the line, try swimming away from it. If it follows you, then you are caught. If the entanglement is easily accessible, you can try to free yourself. Otherwise, signal your buddy, because further efforts on your part may result in worsening the entanglement and stirring up silt. If your buddy is unable to free you, then as a last resort you will have to cut the line. Before doing so, all the divers must be on the exit side of the planned cut. The line is then secured to a rock, cut, and the team exits.

When visibility is reduced—for whatever reason—to the point where you cannot easily see the line or your other team members, you should abort the dive. Specific procedures for alerting other team members and for following the line out of the cavern in reduced visibility have been devised. These procedures will be discussed in later chapters.

In some caverns you may encounter permanent lines installed by other divers. These may meander for thousands of feet, through complex mazes of passageways, and they may be in very poor condition. A diver who is unfamiliar with these lines and how to navigate along them can easily become disoriented and lost. A wrong decision as to which way to go, and you will be swimming deeper into, not out of, the cave. Trained cave divers use a variety of specialized techniques and equipment in order to know which way to go, and to repair lines that are in bad condition. Until you acquire the proper training and equipment you should avoid using permanent lines altogether and rely strictly on your own line.

Factors Affecting Line Technique. Laying and retrieving line is made more difficult by currents. Strong currents are particularly difficult to swim against when your hands are occupied with a reel. When exiting, since both your hands are busy with the reel, you will need to stop in order to vent air from your BC, to free the line from snags, or to keep from overtaking the divers ahead. Where silt is not a major concern, you can make yourself slightly negative and sink to the cavern floor. Alternately, you can use your feet to drag along the cavern walls or the floor if necessary to keep yourself in control.

If the line becomes slack, the reel may jam. If the jam is minor you might be able to free it during the dive. Before trying

to do so, however, first insure that you do not cause silting while working on the reel. Either increase your buoyancy and float to the ceiling, or, if the cavern floor is not too silty, settle gently to the floor and remain still while freeing the line.

If you cannot free the line easily, you have three alternatives. 1) You can tighten the lock nut on the reel and leave it to be retrieved later with full tanks. 2) You can wrap the line around the reel, tightening the lock nut down first so that the reel doesn't unspool by itself, and straighten it out on shore. Or 3) You can cut the line. Do this by first securing the line. Then make sure that everyone is on the outbound side. Tighten the lock nut on the reel, cut the line, and then exit the cavern. Whichever you decide to do, remember that the most important consideration is the safety of the team. Any problem, like jamming the reel, disrupts the smooth flow of the dive and may therefore lead to additional, more severe problems later. Therefore, if you cannot immediately solve the problem underwater, abort the dive.

Although the line is your guide to the surface, it can also create problems such as reel fouling and line entanglement. To use the line and reel effectively takes training and practice. This practice is best done in open water until you become reasonably proficient.

Chapter 7

Underwater Communications

The difference between two divers being in the water at the same place at the same time, and a two-man buddy team, is communication. This communication begins long before the divers ever get in the water, with the formulation of a dive plan. As the dive unfolds, the divers may have to deal with some unexpected problem or may find it desirable to modify the plan. Within the parameters of the buddy system, this can be accomplished smoothly and safely only if the divers can communicate effectively with each other. To this end, cavern divers have modified some existing underwater communication techniques and devised others to fit their specialized needs.

All underwater communications begin by attracting your buddy's attention. Open-water divers are taught that one effective means of doing this is to bang on the tank. In the unique environment of the cavern, this has been found not to work very well, as the walls and ceilings dissipate and absorb the sound. In addition, if you're wearing a wetsuit hood, or diving in freshwater (which has poorer sound transmission characteristics than seawater), aural communication is further impaired. Cavern and cave divers do not even include any audible signals in their underwater vocabularies, but rely instead on visual signals and actual physical contact.

Before they make their first cavern dive, many open-water divers visualize it as being a lot like night diving, and in many respects it is. But students are taught that when night diving, if they have a communications problem or if buddies become separated, they are to go up to the surface. Cavern divers do not have this immediate option. Therefore, they need a much more extensive underwater language.

Light Signals. Because of low light levels and the possibility of sudden visibility loss due to silting, cavern divers

must stay close together throughout the dive in order to be able to communicate effectively. At a distance, illuminated only by the light from the cavern entrance and the narrow beam of a hand-held light, one team member may not be distinguishable from another. Furthermore, if the water is turbid, a diver may blend in with the cavern walls and you may not be able to see him at all. The only signal you would be able to see would be one using his hand-held light. If that were to fail, he would have no way of signalling you, unless he was carrying a back-up light. Under these conditions a chemical light, such as a cylume, would most likely not be visible; therefore, such chemical lights must not be used in lieu of either of the required battery-powered dive lights.

Observation of your dive buddies' light beams during the dive can tell you a great deal about how close behind they are and how the dive is going for them. If their light beams move slowly and carefully, as if systematically scanning the cavern passage, then all is probably well. However, if their light beams move erratically, it may be because they are struggling with a problem and need your assistance. Just as you must frequently monitor your pressure gauge, depth gauge, and watch, you must also consciously monitor your buddies' light beams. This does not, however, relieve you of the responsibility for turning around and checking on your buddies visually from time to time.

At all times during the dive, be careful not to shine your light into your buddies' eyes. A strong light directed into a cavern diver's widely dilated pupils may cause temporary blindness, or will at least reduce his effective vision for a period of time. While intuitively obvious, this point is frequently overlooked, not once but many times during a cavern dive.

Communicating with dive lights is easier when all the divers have the same strength light. This is because a weaker-intensity light will be overpowered by a stronger-intensity light, and the buddy with the weaker light will be less able to attract the other team members' attention. This also holds true for back-up lights.

It is important to take the various dive-light strengths into consideration when establishing the diver order for the dive. Should the diver with the weaker light be the reel man on a two-man team, he will be at a distinct disadvantage on the way out of the cave should he need to signal his buddy. If the diver with the weaker light is the second diver into the cavern, he will have difficulty signalling the reel man on the way into the cavern. In a three-man team, the weakest light can be placed in the middle, and the diver relies on his buddies to relay communications for him if

necessary. But in all cases, using a significantly weaker light places an added burden on the entire dive team.

To signal another diver ahead, look for where his light is shining (which is usually where he's looking), and cross his beam with yours. If you have a serious problem or emergency and you urgently need to get his attention, flash your light rapidly back and forth across the spot where his light is shining. This tells your buddy that his immediate attention is required and that he should start swimming towards you. If you want his attention for a less urgent purpose—to point out something on a wall, or to communicate some other message—then cross his light and move your light up and down with several quick, but distinct strokes. Then you can point out a feature in the cavern by slowly moving your light towards the object and circling it. His light following yours is confirmation that you have his attention. To direct his attention to a hand signal or other communication, move your light beam along the wall or floor, back toward yourself.

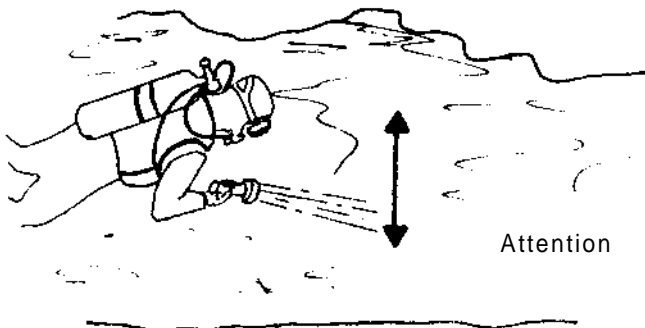
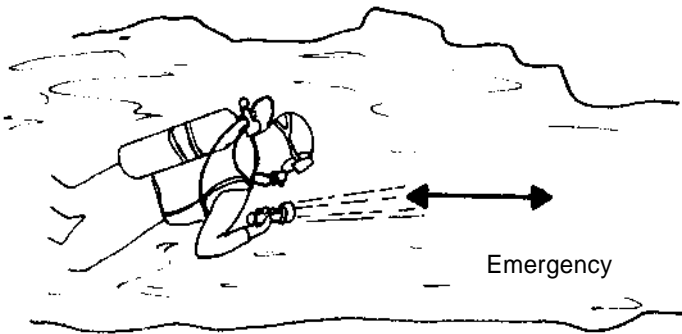

Because these are special, attention signals, it is important that you make an effort to keep your normal light movements slow and steady, as opposed to short and jerky. That way when you do need to attract someone's attention, it will be particularly noticeable. You can expect some erratic light movements by the reel man as he winds in the line. Because it may be difficult to distinguish these jerky movements from emergency signals, keep your eye on him so as to be able to render any assistance that might be needed.

By making a slow circle around your buddy's light you are telling him that you are okay, and asking him if he is okay. He should return the circular signal. If he doesn't acknowledge it, repeat the signal a second time. If there is still no answer, assume that he needs your assistance.

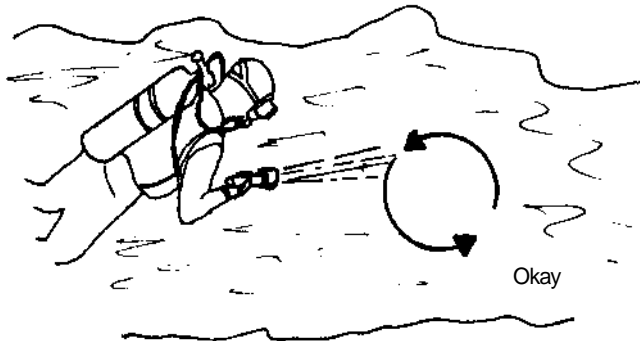

In a three-man team it is the middle man's responsibility to relay messages between the other two divers. When the lead diver asks the middle diver if he is okay, the middle diver is answering for both himself and the third diver, and it is his responsibility to make sure that the third diver is, in fact, all right, too. If either diver at either end signals a problem, it is the middle diver's job to respond to the problem and signal the remaining diver. If the problem is life threatening, he should respond immediately; if not, he should signal the other diver, and then both of them should respond.

Even though you can learn a lot from your dive buddies' light beams, they don't tell the whole story, and you must make a visual check fairly frequently. In good visibility, the divers ahead of you are easy to see. But to see divers behind, you must turn around to look at them. The problem in a cavern is that stopping and turning

around can often cause localized silting in addition to disrupting the smooth progression of the dive.

One method of looking back with minimal possibility for silt disturbance is, as you're swimming in horizontally level trim, to bend your head down and look through your legs at the other divers. This has the disadvantage that both you and your regulator must be able to function upside down, and that you must be able to correctly interpret what you are seeing from this inverted perspective. Another method is to roll onto your side and look over your shoulder. The difficulty here is that this might cause a dramatic shift in your buoyancy. Also, you will want to keep a little forward momentum to stay in control and prevent silting.

Hand Signals. Once you have your buddy's attention with a light signal, you can then communicate with hand signals, which allow more complex ideas to be expressed. It is essential that each diver clearly understand all the hand signals that might be required during the dive. These hand signals will be most effective if they are standard hand signals that are widely known and if they have been reviewed prior to the dive.

The hand signals should be given with clarity, exactness, and boldness. Because there will probably not be enough natural light in the cavern to adequately illuminate your hand signal, you will have to shine your light on your hand so that the sign is clearly illuminated and visible to your buddy. You must also be careful during the signing process not to inadvertently shine your light into your buddy's eyes.

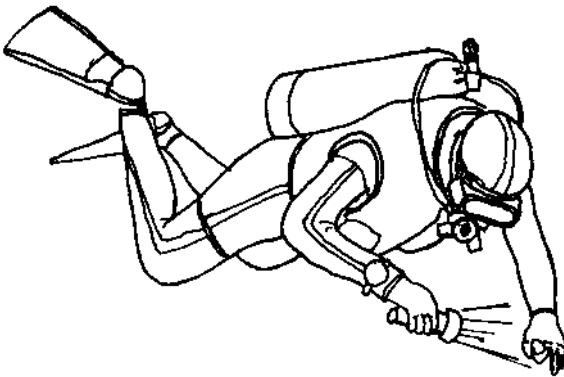

Shine your light across your hand to illuminate a hand signal - avoid shining it into your buddy's eyes

There are three command signals. They are called command signals because they must be answered and must be answered in a specific manner. These three signals are the OK signal, the HOLD signal, and the SURFACE signal.

OK: This is the most frequently used sign. When it is given as the initial sign, you are saying, "I'm okay. Are you okay?" This sign must be answered with a sign by your buddy. He may, and most likely will, return the OK sign, in essence telling you that he is okay and that everything is fine. If you do not receive the OK sign in response, then you should investigate further, because there may be a problem. If your buddy only nods affirmatively in response to your OK hand signal, this is not acceptable. Nodding is too ambiguous, whereas the OK hand sign is a distinct, precise message. The fact that your buddy is not properly



responding may be an indication that he is under stress and may not be fully in control of other aspects of the dive as well. Other acceptable responses to the OK signal are another command signal or a description of a problem. Unless the situation is completely resolved and affirmed with OK signs all around, the dive must be aborted.

HOLD: This sign means "Hold still. Wait. Go no further." The only acceptable response is a return HOLD sign—and then of course, waiting and going no further until cleared to do so with an OK sign. If your buddy responds to the HOLD sign with any other sign, including the OK sign, it may mean that he misunderstood you and is responding to something else. An initial HOLD may mean that the diver giving the command needs to stop briefly to adjust something, or that



he may not want to go any farther into the cavern, or that he wants to have a conference, followed by additional hand signals.

SURFACE: This sign means "The dive is over. We are going to the surface." This is a no-nonsense signal and is not open for debate. The only acceptable response is a return SURFACE sign from each member of the team. Cave divers have a saying:

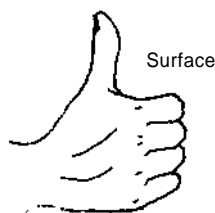

"Anyone can call (terminate) a dive at any time for any reason." Everyone must respond so that it is certain that everyone understands that the dive is over. All divers then exit the cavern in an orderly fashion. Because SURFACE is a command sign and you don't want any confusion regarding it, cavern divers do not use any other signs that could be easily mistaken for it, such

as directionals involving the hitchhiker thumb.

These three commands communicate essential information about the status of the dive. The OK sign, sent and received, indicates that the dive may proceed. The HOLD sign, sent and received, means that the dive is temporarily halted. The SURFACE sign, sent and received, means that the dive is terminated and the team will exit the cavern. Specific responses confirm that the message was understood and will be acted upon.

Although the meaning of each of these commands is unequivocal, there can be varying degrees of urgency, usually expressed by the intensity with which the sign is delivered. For example, a steady, calm SURFACE sign implies that there are no particular difficulties, but that it is time to end the dive. A vigorous, moving up-and-down SURFACE sign implies that there is some urgency to leave the cavern. A very violent SURFACE sign indicates a severe problem, requiring immediate evacuation. Although divers should be careful to try to perform the SURFACE sign properly, assume that any sign that resembles or even suggests surfacing can be intended to mean surface. Sometimes when stressed, divers may forget the proper signals.

Beyond the basic information conveyed by light signals and command signs, cavern divers need to express other, more complex ideas concerning themselves, their environment, and their equipment. Suppose, for example, you are having trouble clearing your ears. Or perhaps you notice that your buddy is kicking up some silt or that the line has become slack. While these are not life threatening, they are all things that need to be corrected before you can proceed safely with the dive. Because some of the concepts that you need to communicate are unique to the cavern environment, certain open-water signs have been modified, while other, completely new signs have been created. In

addition, signs are often combined to express a more complex message.

QUERY: This sign indicates a question. It is usually followed by another sign. For example, QUERY—{point to your buddy}—{point to your pressure gauge} = "What is your air pressure?" However, QUERY can also stand alone, indicating that you didn't understand a sign directed at you, and want it repeated or further clarified.

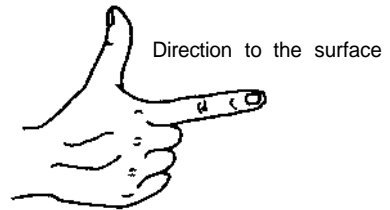
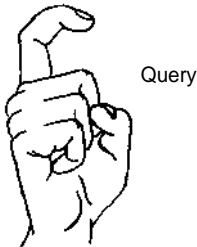

DIRECTION TO THE SURFACE: This sign is used to point the direction out of the cavern. QUERY—DIRECTION TO THE SURFACE = "Which way do we go to get out of the cavern?"

PROBLEM: This sign is used to tell your buddy that a problem exists. If the PROBLEM sign is prefaced by the QUERY sign, you are asking, "Is there a problem?" Signals that follow the PROBLEM sign indicate the nature of the problem. For example, PROBLEM—{point to your ear} = "I have a problem with my ears."¹ If you were to sign QUERY—PROBLEM—{point to your regulator}, you would be asking, "Is there a problem with my regulator?" and requesting that your buddy inspect it.

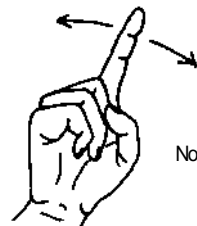
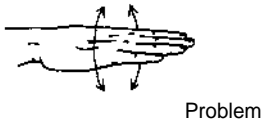

YES and **NO:** To respond affirmatively to a question, use the OK sign. There is usually no difficulty about confusing this meaning of the OK sign with the OK command, since the OK sign here answers a query, rather than initiating it. NO means just that: No.

SILT: This sign is used to indicate the existence of silt. The SILT sign combined with pointing at a section of the cavern floor is a warning that the area is covered with silt. SILT—{pointing at your buddy} = "You are stirring up silt."



Silt



Big or a lot



Small or a little

BIG and LITTLE: These signs indicate relative size. For example, BIG—SILT—{point at your buddy} = "You are stirring up a lot of silt."

BUBBLES: This indicates an air leak. LITTLE—BUBBLES—{point at your buddy} = "You have a small air leak."

Bubbles
(repeat
several
times)

Line

LINE: This sign indicates the line. For example, PROBLEM—LINE = "There is a problem with the line."

ENTANGLEMENT: This tells your buddy that you are entangled in the line. For example, QUERY—{point to your buddy}—ENTANGLEMENT = "Are you entangled in the line?"

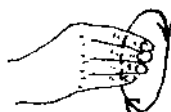
Entanglement
(repeat several times)

Reel

REEL: This sign refers to the reel. For example, PROBLEM—REEL = "I am having trouble with the reel."

TIE-OFF: This sign means to tie off the line, TIE-OFF—{point to location} = "Tie the line off here."

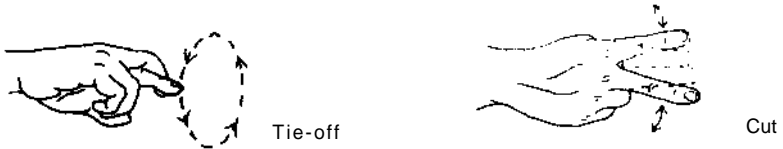

CUT: This sign indicates that the line is to be cut, and is usually followed by SURFACE. If a line has to be cut, all divers must be on the exit side of the line.

BACK-UP LIGHT: This sign lets your buddy know that he has a back-up light on.

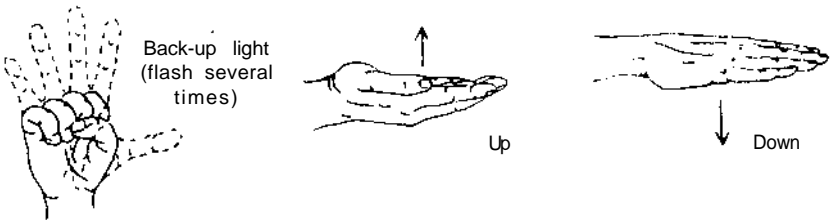

UP and DOWN: These signs are used to indicate up or down movement within the cavern in place of the traditional open-water signs in order to avoid any possible confusion with the SURFACE command. You might indicate DOWN to your buddy to suggest that you explore the floor of the cavern, or UP, in conjunction with the SILT sign, to suggest that you move away from the floor.

TUNNEL: This sign means cavern passage or tunnel. For example, BIG—TUNNEL—{point at location} = "There is a big tunnel over there."



CURRENT: This sign indicates water flow or current. For example, LITTLE—CURRENT = "There is a little current here."

SLOW DOWN: This sign means that you want your buddy to swim more slowly. For example, HOLD—SLOW DOWN = "Hold. Slow down. You're swimming too fast."

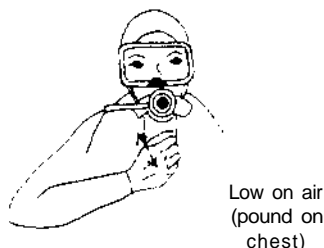
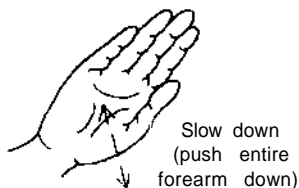

LOW ON AIR: This is indicated either by pounding on your chest or by pointing to your pressure gauge and signing SURFACE.

OUT OF AIR: This sign indicates that you are out of air and need to share air immediately.

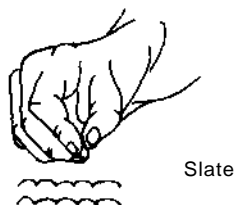
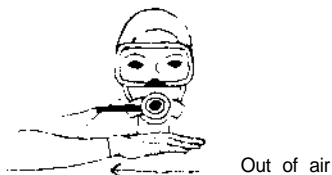

SLATE: This means that you want your buddy to write his message out. Remember that writing a message down underwater not only takes time, it requires that you be in a stable position where you will not stir up silt. For a nonessential message it may not be worth the trouble or the risk of silting.

Touch Contact. The primary drawback of all the above means of communication is that they rely on light and visibility. If those are lost, then the divers have no way of communicating other than physical touch.

As a cavern diver you should be within arm's length of the line at all times. As visibility decreases, you should reach out and make contact with the line. You do this by making an OK sign around the line, interlocking your thumb and forefinger around it so that it slides easily inside the "O" made by your thumb and

finger. If you do not interlock the thumb and forefinger, the line could be jerked from your grasp. However, you do not want to grip the line tightly, as you may pull it loose from a placement or anchor, or away from another buddy.

After making contact with the line, you turn to face the entrance. If you were heading in, you turn around to go out. If you were already headed out, stay put and don't move.

While maintaining contact with the line at all times, the reel man must secure the line by wrapping it around a projection and then locking the reel off. If no projection is available, lock the reel off and drop it. Locking the reel off prevents the line from spooling off on its own. Abandoning the reel insures that the reel man will be able to remain in touch contact with the rest of the team. Do not attempt to reel the line out in zero visibility. It can be retrieved later on another dive.

With an interlocked OK around the line, the reel man swims towards entrance with his free hand in front searching back and to make sure he does not run into anything or hit his head, until contact is made with the second diver. Once contact is made, the divers must make sure they are on the same side of the line with the same hand on the line. The reel man can grip the second diver either on the leg or on the arm that is attached to the line. Now simple communications can be transmitted back and forth.

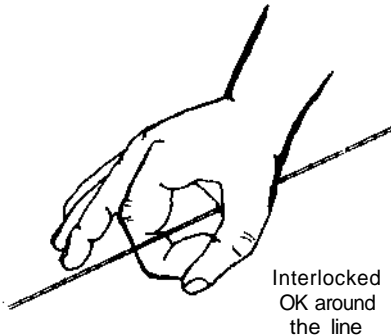

The simplest of these are STOP and GO. If the reel man pushes on the arm or leg of the second diver, it means GO. If he pulls, it means STOP. Continued pulling beyond that means BACK-UP. Now both divers can proceed until they exit, or locate the third diver if it is a three-man team. It is important that the diver leading the exit keep his free hand out in front searching for obstacles.

If the rear diver pushes and the front diver doesn't move, then this means that the front diver has a problem. Similarly, if the rear diver keeps signalling STOP every time they attempt to move, it means he has a problem. If it is a line entanglement, the

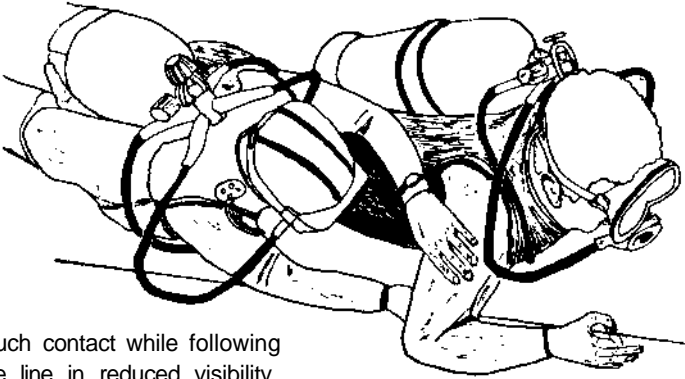

Touch contact while following the line in reduced visibility

entangled diver can move his line hand along the line until he encounters the other diver's hand. He can then make the LINE sign and force his fingers between the other diver's hand and the line. Other signs can be communicated in this same way. For example, HOLD TIGHT TO THE LINE, squeezing the diver's hand on the line, telling him not to let go, while you try to solve the problem.

If the lead exit diver comes to a place where he must cross over to the other side of the line, he crosses over, then stops, indicates to the next diver to HOLD TIGHT TO THE LINE, and moves the other diver's free hand to the line. If he cannot find the free hand, pulling on the hand that is on the line is most effective, because the free hand will almost invariably come flying to the line. Now he squeezes on the new hand to HOLD TIGHT ON THE LINE. The rear diver's new free hand is now put back into proper position on the lead exit diver's arm or leg, and the exit continues.

If a diver needs to share air in zero visibility, then he has no alternative but to grab the necessary regulator from his buddy. Because the logistics of maintaining position on the line while sharing air are formidable, experienced cavern and cave divers prefer to carry 5- or even 7-foot hoses for air sharing. That way they can both stay on the same side of the line and continue to communicate by touch while navigating along the line. Cave divers have used this method successfully to share air in zero visibility for thousands of feet. Air sharing in zero visibility is discussed in more detail in the Emergency Procedures chapter.

Chapter 8

Dive Planning

Very few elements of a cavern dive contribute more to the divers' safety than a well-conceived dive plan. A good dive plan brings together all the capabilities of the dive-team members—their abilities, knowledge, skills, and experience. It details the planned sequence of events, defines responsibilities, establishes the parameters of the dive, and discusses contingency plans.

Defining an Objective. Each dive has an objective—the reason for making the dive, the answer to the question, "Why are we going into the cavern?" An appropriate objective might be, and often is, simply "to go in and see the cavern." On another dive your objective might be to take pictures in the cavern. Or if you are a geologist or biologist, your objective might be to study the rock or the animals living in the cavern. Whatever the objective, it is important that each team member understand what it is and that the entire team agree upon it.

The dive objective establishes the foundation for the dive plan. By clearly stating the purpose of the dive to all team members in this way, and defining how it will be conducted, each team member will be better aware of what the others can be expected to do on the dive, and better able to evaluate the progress of the dive.

However, attaining the dive objective should never be allowed to overshadow normal safe diving practices. A personal or team goal to reach some new area of the cavern or to accomplish some specific task is never an excuse for failing to maintain good buddy contact or for violating standard safety procedures. The dive objective, while a unifying influence on the dive, must always remain secondary to conducting a safe dive.

Formulating a Dive Plan. Once you have defined an objective, you must formulate a dive plan that will allow you to achieve the objective with maximum safety. Significant elements

of a well-conceived dive plan include 1) dive-team selection, 2) dive-site considerations, 3) establishing limits, and 4) reviewing standard diving procedures. This plan should be formulated by all team members well in advance of the dive, before gearing up, and reviewed during the pre-dive check.

Dive-Team Selection. An ideal dive team is composed of individuals of similar ability, skill, and experience, who dive together frequently and know each other's diving habits. Such an ideal balance of abilities within a team is seldom realized. It is more likely that the team consists of individuals of differing abilities, experience, and personal motivations. Therefore, a critical element of dive planning is to formulate the plan around the capabilities and limitations of each team member.

When the team consists of individuals with widely differing levels of ability and experience, then the dive plan should not exceed the ability of the least experienced member. This last point is particularly important since it is common for weaker team members to overstress themselves trying to keep up with the more experienced divers. Allowing a dive-team member to operate under such self-imposed stress is to invite an accident. Instead you should foster in your team the philosophy that ***any diver can call any dive at any time for any reason, and the decision by one diver to terminate the dive ends the dive for all the others.*** Such a diving philosophy can only enhance the overall safety of the entire team.

The ideal team size is three divers, although teams of either two or four divers are also acceptable. When diving in a three-person team there are two buddies to help a diver in need of assistance. With more than four divers on a team, it is difficult to keep track of all the divers and to keep the team together. Solo cavern diving, like solo open-water diving, is discouraged.

Dive-Site Considerations. Each dive plan must include consideration of the conditions found in the cavern to be dived. When diving in an unfamiliar cavern, it is useful to obtain information about the cavern from local divers. You must be cautious, however, in evaluating this information since it may prove inaccurate, particularly if the source is not a trained cavern diver. Even when diving a familiar cavern, you must be cautious, since conditions may have changed sufficiently from your last visit to require a different approach to diving there.

For example, after periods of heavy rainfall, tannic or

muddy waters may cover a cavern's surface pool and prevent the usual surface light from penetrating into the cavern. Thus, even though the water inside the cavern might be clear, lack of daylight would make what would normally be an easy and safe cavern dive, into a full-fledged cave dive. For the same reason—lack of daylight from the entrance—there is no such thing as a cavern dive after dark.

Establishing Limits. Specific limits must be defined for every dive. These are determined by the available direct daylight within the cavern; the maximum linear distance from the surface; the depth, breadth, and configuration of the cavern; the absence or presence of restrictions; the general visibility; your nitrogen profile relative to the no-decompression limits; and your air duration. The NSS Cave Diving Section has established specific limits for all of the above categories for cavern diving under ideal conditions. Although you may choose to adopt limits more conservative than these, and are encouraged to do so when conditions are less than ideal, you should never exceed these limits without further training and equipment.

Direct Sunlight. The underwater cave may be subdivided into three zones based on light: 1) the direct-sunlight zone, 2) the ambient-light zone, and 3) the zone of total darkness. As a cavern diver, you are restricted to the direct-sunlight zone. Anything beyond that is a cave dive and must be treated as such.

Maximum Linear Distance from the Surface. Cavern divers must stay within a linear distance of 130 feet from the surface. The linear distance is equal to the depth at the cavern entrance (the distance straight down from the surface to the entrance) plus the penetration into the cavern. For example, if the cavern entrance starts at 30 feet, the diver may penetrate into the cavern a swimming distance of no more than 100 feet. If the cavern begins at 50 feet, the diver may go in no further than 80 feet. However, depending upon the difficulty of the cavern, silting conditions, current, etc., you may want to set your personal diving limits more conservatively.

Depth. The maximum depth for diving in a cavern is 70 feet. Below 70 feet, air reserves for dealing with emergencies are too limited and the margin for error becomes too critical.

Restrictions. A restriction is a localized narrowing in a passageway which is too small for two divers to swim through comfortably side by side. Cavern divers are not permitted to pass

through restrictions in part because sharing air with standard scuba through a restriction is nearly impossible.

Minimum Visibility. The minimum visibility acceptable for cavern diving is 40 feet. If the visibility deteriorates below this minimum during the dive due to silting or weather conditions, the dive should be terminated.

No-Decompression Limits. Cavern divers should stay well within the no-decompression limits. When cavern diving, bottom time is defined as the time from leaving the surface to returning from the cavern to a depth of 10 feet in open water, rather than the time from leaving the surface to beginning the exit from the cavern. Most experienced cavern divers plan to stay within at least 80% of the no-decompression limits to allow for any unexpected delays encountered during the exit from the cavern.

Air-Supply Limitations. One of the three leading causes of death in underwater caves is failure to reserve adequate air for the exit. Although it should seem obvious that one must terminate a cavern dive with enough air to insure a safe exit, many divers fail to do so.

When diving in open water, "exiting" means swimming directly to the surface. Open-water air reserves are built around the concept of sharing air with an out-of-air buddy all the way to the surface. This can be a difficult task for seasoned divers, even if nothing else goes wrong. However, cavern-diving reserves must be built around the concept of sharing air with an out-of-air buddy all the way out of the cavern from the maximum point of penetration and *then* to the surface. ***This requires at least as much air from your one cylinder as both of you used coming in on two separate cylinders.*** Consider also the added problems you may encounter trying to share air while at the same time navigating along a line, possibly in reduced visibility, and probably without your buddy having any means of controlling his buoyancy.

Suppose you and your buddy start a dive with 3000 psig each, and your objective is to explore the far recesses of a cavern. At the far side of the cavern, you notice that you have 1500 psig—about half of your air supply. At this point your buddy signals to you: "Out of air!" It took you each 1500 psi to reach the back of the cavern swimming straight in at a moderate pace, yet you now have only 1500 psig in one cylinder for the two of you to exit on—

or 750 psig each. The tragic result of this air planning should be obvious.

Suppose the air failure occurred when you had 2000 psig remaining in your tank, leaving you with 1000 psig each for the exit. You might just make it out of the cavern—provided you can use your air as efficiently coming out as you did going in.

Thus, the bare *minimum* reserve for the trip out of the cavern is $2/3$'s of your starting air supply. One third in, one third out, and one third for your buddy. If you start with 3000 psig, then you would turn around to exit with no less than 2000 psig in your tank. If you start with 2800 psig, or some other number not easily divisible by 3, drop down to the nearest number that is easily divisible by 3 (in this case, 2700). Take $1/3$ of 2700 psig (or 900 psig) and subtract it from your original pressure, 2800 psig, to get a turn-around pressure of 1900 psig. Be sure always to subtract the third from your original starting pressure; otherwise, you will end up turning after using more than a third of your starting air supply.

But this assumes that in the worst-case scenario—air failure just as you reach your turn-around pressure, at maximum penetration in the cavern—you can swim out sharing air as efficiently as you swam in. It also assumes that you don't encounter delays, such as line entanglements, bad visibility—or no visibility—from diver-induced silting, buoyancy-control problems (since your out-of-air buddy has no auto-inflate capability), or other equipment failures.

This bare-minimum reserve assumes that both divers are using the same size cylinders filled to the same pressure, and that they breathe at the same rate. However, this is not always the case.

Suppose a husband-and-wife team goes cavern diving, using a tank system that works well for them in open water: he dives an 80-cubic-foot cylinder, while she dives a 50, and their breathing rates are such that they both have similar bottom times. If they plan their dive so that they will turn when the first person reaches the $2/3$'s minimum reserve, then in a worst-case scenario, with the husband needing air at maximum penetration, there is an inadequate reserve in the wife's 50 ia bring both divers out.

When diving different size cylinders, you must compute your minimum turn-around based on the smaller air volume. At

standard temperature and pressure, a 50-cubic-foot tank filled to 3000 psig holds =50 cubic feet of air. Filled under the same conditions, at 3000 psig an 80-cubic-foot tank holds =80 cubic feet of air. Your minimum turn-around with a 50 would be 2000 psig, having used =16 cubic feet, leaving you =34 cubic feet for the exit. The diver using the fully charged 80 must turn the dive after using =16 cubic feet of air (or at =2400 psig). This will insure that both divers have the minimum amount of air required to breathe each other out at all times during the dive. Assuming that you breathe =1 cubic foot of air per minute at the surface, at 60 feet, your 16 cubic feet would last about 5 minutes. Therefore, while it is theoretically possible for cavern dives to be made with small-capacity cylinders like 50's, most cavern divers prefer the larger volumes of air available from 71.2- or 80-cubic-foot cylinders.

Suppose two divers with the same air-consumption rates plan a cavern dive using the same size cylinders, but with different starting pressures. One has 3000 psig; the other has 2500 psig. If each calculates his minimum reserve based on 2/3's of his own cylinder, independent of the amount of air in the other diver's tank, the diver with the larger fill will be expecting to turn after using 1000 psi, while the diver with the smaller fill will be expecting to turn after using 800 psi. This may work as long as the two divers do, in fact, breathe at the same rate. If, however, the diver with the larger air supply should breathe more heavily, due to exertion, stress, etc., he could easily breathe 1000 psi before the diver with the smaller air supply has used 800 psi. In a worst-case scenario, the diver with the smaller initial air supply would not have enough air to bring both divers out. Therefore, both divers should plan their turn-around pressures based on the smaller air supply, turning after either one has used 800 psi.

Diving in a siphon cavern also requires that you reserve more air for your exit. It is often difficult to determine how much additional air is needed to exit a siphon since the amount needed will vary with the strength of the current and the cavern configuration.

Ideally, you should begin such dives by adopting a very conservative air rule, such as 1/6 of your starting air supply for the trip in. If you note your starting tank pressure, actual turn-around pressure, and exit tank pressure, you can then use this

data to plan your next dive, following the basic principle of air management already described.

For example, suppose you started a dive into a siphon cave with 3000 psig, turned at 2500 psig, and exited with 1800 psig. You used 500 psi to enter and 700 psi to exit. Since you used 700 psi/500 psi or 1.4 times more air to exit than to enter, you must reserve at least twice this amount, or 2.8 times more air, to exit. Thus, you partition your air supply into 3.8 parts (1 part in + 2.8 parts out = 3.8 parts). Or for simplicity's sake (and to add a slight additional margin of safety), round it up to 4 parts. You would then use 1/4 of your air to enter, and reserve 3/4's to exit. 1/4 of 3000 psig is 750 psig. But because pressure gauges are most clearly readable in increments of 100 pounds, round this number down to the nearest 100, or 700 psig. Therefore, your minimum turn-around pressure would be 2300 psig. Remember, however, that the cautions about using the different sized air supplies still apply.

Review of Standard Dive Procedures. In discussing your dive plan it is generally a good idea to review the hand signals you may need to use during the dive. This review will insure that all team members are aware of and understand the signals they need to know. Similarly, you should also review the emergency procedures that you may need to use during the dive. This is a good time to remind everyone that anyone can call the dive at any time for any reason and that the entire team must exit together.

Pre-Dive Check. A final pre-dive check should be conducted by the divers in the water just prior to submerging for the dive. This pre-dive check consists of a review of the dive plan, a final equipment check, and an air-sharing safety drill, sometimes called an **S-Drill**.

The team leader should briefly review the dive plan with the team to insure that everyone still remembers the plan clearly. The highlights of the review should include the order in which the divers enter and exit the cavern; planned maximum depth, penetration, and time; and the route to be followed if known.

This completed, all divers should check their: submersible pressure gauges and calculate their turn-around air pressures, making adjustments as may be required to account for varying cylinder pressures and volumes within the team. Announce this

pressure, along with your starting pressure, to the other team members, and write them both down on your slate. If you suspect you might have trouble remembering your turn-around air pressure you can mark it on your submersible pressure gauge.

Next check that you have all of your equipment and that it is working properly. The check is usually conducted by the team leader by matching equipment, and begins at the head and works all the way down to your feet. It starts with the mask—not only that you have it but that the straps are in good condition. Next everyone checks to make sure all valves are turned on. Then everyone checks to make sure that the regulators are functioning properly. Take a few breaths from both second stages underwater to insure that they breathe properly and confirm that your inflator is working. Detach each light and momentarily turn it on. As you conduct all of these checks announce the results to the dive-team leader. You continue with this matching check for each piece of equipment you have.

The equipment-matching process may seem time consuming and meticulous. It is. However, it also checks every bit of equipment every diver carries. Should a piece of gear be found missing or wanting, your dive is merely delayed while the problem is corrected. Should you skip this proven method, then you may not discover a missing or defective item until an emergency develops. Conducting this final check in the water allows the detection of equipment which may have been damaged while in transit to the water.

When this initial equipment check has been completed, all divers should submerge and check each other for air leaks. Common places for air leaks are the the tank valve, valve-to-regulator O-rings, high-pressure hoses, auto-inflator hoses, and BC's.

The final part of your pre-dive check is the S-Drill. Before every cavern dive you should conduct an air-sharing S-Drill with each diver. Each diver in turn signals, "Out of air," receives the octopus from his buddy, and then the two swim a few feet as if to simulate swimming out of the cavern. This drill requires only a minimum amount of air, and establishes the ability of all team members to octopus-breathe with their buddies should an air-supply failure occur on the dive. It also reconfirms which regulator each diver will pass off. If there is a third member of the team, he should observe the S-Drill while awaiting his turn.

Should any difficulties arise, the drill should be repeated until corrected. Then all divers return to the surface.

Final, exact air turn-arounds are calculated and recorded on the slate for future reference. The team is then ready to begin. A good way to do this is for the team leader to announce that the dive will start in 1 or 2 minutes. That allows each team member to write down on his slate the time of submerging, set his watch bezel or timer, and make any other minor equipment adjustments prior to beginning the dive.

Post-dive Discussion. Upon reaching the surface at the completion of each dive, write down on your slate the maximum depth achieved during the dive, bottom time, the time you surfaced, and remaining cylinder pressure. This information will be useful later if you decide to make a repetitive dive, and can be jotted down in your logbook to be used as an aid in planning future dives.

You should then hold an in-water post-dive discussion. This discussion not only provides a rest period ("surface decompression") immediately after the dive, but is also an excellent opportunity to share your impressions and experiences of the dive with the other team members. In this way you can all grow in your knowledge of caves and cavern diving by profiting from the experiences of the others.

If the dive did not go well, this is the time to determine why. Problems should be discussed candidly. Sharing the problems and stresses of the dive will make both you and your buddies better divers. Such constructive self-criticism will enhance your overall team safety.

Chapter 9

Psychological Aspects

What motivates people to go cavern diving? For some it is a natural extension of open-water diving. Caverns are frequently easily accessible, and offer warm temperatures and good visibility; they can offer a nice alternative to rough cold seas. For others, it is the innate human fascination with dark holes in the earth. Still others are impelled by the desire "to boldly go where no man has gone before," also known as the "Star Trek Syndrome."

There is also, unfortunately, a minority who are "thrill seekers," to whom cavern diving affords an opportunity to "cheat death." It is equated in their minds with taking drugs, speeding in cars, solo diving, deep diving, and a variety of other daredevil activities. These are the divers who put safety second and ego gratification first. They might not be the type of buddies you really want on a cavern dive.

Cavern diving is not for everybody. If you know that you are claustrophobic or that dark places make you feel uneasy, or if you are new to scuba diving and not yet proficient in the basic skills, or if you are uncomfortable with the idea of being unable to ascend directly to the surface, then cavern diving may not be for you.

As a responsible cavern diver, you must learn to analyze your own motivations and those of the other divers in your team, and to recognize factors that might compromise the safety of the team. Mature judgment, along with a free and clear mind, are the most important pieces of diving equipment the cavern diver possesses.

The cavern diver must also have several other important mental attributes. He must be honest enough with himself to accurately assess his own capabilities and limitations. He must have enough self-confidence to back out of a dive when he feels uncomfortable—even if he is already geared up and in the water, and his failure to participate will result in canceling the dive. And

he must also be at ease with himself before cavern diving. If upset emotionally or otherwise distracted by unrelated events, then diving is ill-advised. Cavern diving imposes enough stresses of its own; don't take additional ones with you.

Stress. The Mental Health Association defines stress as "pressure from the outside which can make you tense on the inside," and says that "it is a fact of life." Human beings require a certain amount of stress in order to remain alert, function efficiently, and react promptly in emergency situations. Beyond a certain level, however, stress becomes detrimental both physically and mentally. Under highly stressful conditions, a diver's ability to deal competently with his environment is reduced. When stress becomes so severe that the diver's responses are completely inappropriate and ineffective, the diver is said to be in a state of panic. A panic-stricken diver is a danger to both himself and to other members of the team. Therefore, it is important to be able to recognize the sources and early signs of stress in order to be able to take preventative measures.

Time Pressure. "Aren't you ready yet?" Time pressure often begins on the surface with the rush to get geared up. A diver who feels rushed is always under pressure to catch up with the group. He is more likely to forget an essential piece of equipment or miss a faulty item as he gears up. In the water, he may feel that he's being forced to swim faster than he wants to go, and find that he's concentrating more on trying to keep up than on other important aspects of the dive.

Time pressure can also take the form of having only a limited amount of air—either in which to see the cavern in general, or to deal with a specific problem. When time pressure becomes a significant factor, you must temporarily halt the dive or call it altogether. Air is time. Once in the water, always allow adequate air to deal with any problem. Perhaps this best explains why cave divers typically seem to enter the water with such a superabundance of air.

Task Loading. Task loading is one of the most universally experienced forms of stress in cavern diving. You have to simultaneously run the reel, hold your light, watch the line, adjust your buoyancy, check on your buddy, monitor your gauges, reference your location in the cavern—and do all of this while moving through the cavern without stirring up silt. And this

assumes that nothing has gone wrong. Consider the possibility of also having to deal with a line entanglement or a light failure, share air, or follow the line in reduced visibility or in a complete siltout—or do them all at the same time.

One of the best ways to cut down on task loading is to thoroughly practice all your cavern-diving techniques in open water to the point that they become second nature. The more experience you have, the easier it is to deal with all of these tasks. If your tasks begin to mount up, slow down the pace, or terminate the dive.

Distance and Direction. Realization at the far reaches of a cavern, of the depth and distance that separate you from the surface can be cause for uneasiness. This is compounded when the visibility decreases or you are otherwise less than confident of the direction out of the cavern. For example, when your internal sense of direction says one thing, but the line indicates another, this can be a source of great confusion and uneasiness. And if for some reason you have strayed away from the line and suddenly find yourself past daylight, the realization that you are lost can be traumatic. Staying well within sight of the direct light from the entrance and abiding by the other cavern-diving limitations will do much to alleviate this kind of apprehension.

External and Internal Doubts. Another source of stress is anxiety about your equipment, your buddies, and yourself. If you don't feel confident about the quality of your equipment or the reliability of your buddies (or feel that they are too far away from you), or if you have doubts about your own performance or ability to cope with an emergency situation, you will probably worry about these things. This not only distracts you from other aspects of the dive, but increases your mental task loading and decreases your overall efficiency.

Threats to Your Ego. How many of us have done things we really didn't think we should do, against our better judgment, for no better reason than that everybody else was doing them? Cavern diving is no exception. All too often divers who really don't feel ready to go into a cavern—who don't feel that they have the training, equipment, or experience necessary—allow themselves to be pressured into making a dive. The rest of the group says, "Sure, it's an easy dive. Anybody can do it." And they do not wish to appear cowardly.

Ideally, it would be nice to simply be able say, "Gee, fellas,

"I'm just not up for this kind dive." However, if a straightforward answer is out of the question, it is just as effective to say that you have a sinus problem and need to sit this one out. The important thing is that you avoid making dives that you don't feel ready for. Other divers may use all manner of persuasion to try to get you to dive—dares, insults, ultimatums, claims that you don't love them, and you, too, may counter with all manner of counterpersuasion—up to and including dares, insults, ultimatums, and claims that they don't love you.

Physical Threats. Occasionally, divers are so enthusiastic about diving at their favorite caverns that they will drive all night in order to dive all day. This can easily lead to physical exhaustion. If you are tired, you are unable to think clearly. Even when well rested before a dive, the physical effort required to fight a strong current may cause you to overextend yourself and your equipment. Being out of breath makes it more difficult to manage the routine aspects of the dive, let alone, to deal with problems. If you're huffing and puffing when your regulator suddenly malfunctions, you'll have that much less time to reach your buddy to begin sharing his air.

Water robs the body of heat many times faster than air. As your body attempts to cope with the cold, the blood vessels in your hands and feet will constrict. Your hands and feet will feel cold, and you will have more difficulty swimming in the proper attitude and performing manual tasks such as handling the reel, adjusting your equipment, and writing on your slate. As you become more chilled and start to shiver, it will become increasingly difficult to concentrate or to think about anything other than the fact that you are cold. It is a good idea to turn a dive at the first sign of being cold. Remember also that the decompression tables say that you are "at risk" on "cold or arduous" dives.

If you spend the entire dive fighting your gear, how can you be aware of anything else? If your mask leaks and has to be cleared every few seconds or your fin falls off because you didn't check the strap before the dive, your safety is compromised. If you alternate between crashing into the ceiling and burying yourself in the silt because you're having difficulty adjusting your buoyancy, you won't have much time to perform the other tasks necessary for a safe dive. If you're silted out and unable to see, you will be hard pressed to keep track of the line, your buddy, and the entrance, let alone, monitor your air and other gauges. If

you're low on air, nothing else seems important. And if you're out of air—real or imagined—nothing else *is* important.

Cavern diving is a continuous learning process. If you build up experience gradually and thoroughly, you will be at home with your equipment and familiar with the special tasks required by this unique environment. Experienced cavern divers cope with all of this stress in a routine manner because everything has been practiced so many times that it has become second nature to them.

How to Recognize Stress in Yourself. Early recognition of stress in yourself is the best way to control it. The most recognizable sign is if you become uncomfortable, either physically or mentally. You must identify the source of the problem and correct it, or call the dive, because if left unattended, rarely do things get better. For example, perhaps while exploring a cavern for the first time, you find yourself feeling uneasy. You have an obligation to yourself and to the other team members to slow the pace of the dive down or redirect it closer to the entrance. It is wiser and more enjoyable to split exploration of a cavern into several dives rather than trying to push yourself to accomplish it in one dive.

As the level of stress increases you may notice that you are breathing faster and that your pulse rate is up. You may also experience other internal feelings of apprehension and fear. Fatigue, loss of concentration, being cold, being frustrated, or almost anything else that disturbs the smooth flow of the dive, can be assumed to be stress related—either causing it, or being caused by it.

How to Recognize Stress in Others. Early recognition of stress in your buddies depends on objective clues rather than subjective feelings.

Narrowing of Perception. One of the first signs of stress in your buddy is a narrowing of perception, for example, concentrating on only one item, like the line. You might notice that he's stopped looking around the cavern and isn't paying attention to his silt technique, and is only interested in one thing: the line. Often simple actions like reassurance with the OK sign and moving closer to him can be all that's required to alleviate his stress.

Clumsiness. If your buddy is fumbling with equipment all

the time, or drops things (the reel, his light, his slate, his knife), or fails to put them away, this is probably an indication that he is stressed.

Loss of Awareness. This is manifested when your buddy loses track of the line, or his position in the team, or fails to query you about your well-being or respond properly to your OK command signs. If he responds to your OK command sign by nodding his head rather than returning the sign, this may be an indication that he is stressed.

Frustration. This would be when your buddy has a continued irritation throughout the dive, and seems to be continuously fiddling with a piece of gear, unable to get it to work right. Do yourselves both a favor: call the dive, go back to the surface, and get the problem taken care of.

Monitoring of Equipment. If your buddy appears either to be monitoring his gauges obsessively, or not to be monitoring them at all, he is undoubtedly stressed. Obsessive, repetitive behavior of any kind or the omission of required tasks are both indications that something is wrong.

How the Body Reacts to Stress. There are several different stages in the body's response to stress.

Ignoring It. The first reaction to stress is the attempt to mask it, to ignore it, to refuse to accept it. This is our own ego's reaction to stress: to deny its existence. For example, "I have twenty years of diving behind me; stress cannot possibly affect me." Or "I am going to keep going until *you* call the dive, because I have never called a dive." With this kind of self-image to protect, it can sometimes be difficult to admit to having made a mistake. If your fin strap breaks, you might think, "This stupid fin strap broke," rather than "**I am upset** because this fin strap broke because I didn't check it before the dive," completely ignoring the "I am upset" part.

Mental Narrowing. In the first stages, the diver tends to ignore the stress, because it's not directly interfering with his performance. However, as the stresses accumulate, the diver will begin to experience significant impairment of his ability to think clearly, to reason efficiently, and to analyze the situation logically. There is a tendency to fall back on old patterns that are well rehearsed, for example, swimming in the open-water fashion rather than with the newly acquired anti-silt techniques, or buddy

breathing off a single second stage rather than air sharing with an octopus, even when an octopus is available. The stressed diver will tend to do the things he knows best rather than the things that make the most sense.

Fight-or-Flight Syndrome. When a severe and immediate physical threat is perceived, the human response is the instantaneous activation of the sympathetic nervous system and the injection of adrenaline into the bloodstream, resulting in increased heart rate and respiration. This physiological mechanism is called the "Fight-or-Flight Syndrome," because early in man's evolution, this response gave him additional energy either to fight his way out of his predicament, or run for his life. But as cave-diving author Robert W. Smith once wrote, "Unfortunately, these mechanisms were not all designed with scuba diving in mind."

The increased heart rate and respiration—hyperventilation—not only depletes your air supply faster, but it may also result in a build-up of excess carbon dioxide (hypercapnia).

Stressed to this point, the diver is just barely in control. A minor entanglement, such as a pressure gauge being caught up in the line, has now assumed life-threatening proportions in his mind. He perceives only that he cannot move, and is barely able to try to analyze the situation and find out why he cannot move. He may only be a step away from wide-eyed panic, where his actions become frenetic and no longer correspond with the needs at hand.

Panic. At this stage, the diver is completely out of control and in the grip of total, unreasoning fear. His actions no longer have any necessary correspondence to the requirements of his situation. He is, in a practical sense, not responsible for his behavior. He could even be considered to be temporarily insane. This diver is dangerous and is likely to do anything. Approach him at your own risk.

Coping with Stress. *Praemonitus, praemunitus.* Forewarned is forearmed. Acknowledging that stress will be a part of every cavern dive allows you to begin preparing for it long before you enter the water.

This begins with acquainting yourself with the exact nature of what it is that you're proposing to do. The fact that you are reading this book means that you have taken the first step towards coping with cavern-diving stress. Hopefully, by the time you

finish reading you will be thoroughly convinced of the value of taking a cavern-diving course conducted by a certified cavern-diving instructor before attempting to cavern dive on your own. Remember that reading a book is no substitute for the actual in-water training and skills that you will acquire under the guidance of an experienced, certified cavern-diving instructor. You wouldn't attempt to fly an airplane after just reading a book about it, and the potential hazards of underwater caverns are no less formidable.

Seasoned cavern divers approach a dive with all possible factors in their favor—being in good health, being well rested, eating properly, and of course, not being under the influence of alcohol or drugs. They make sure that the buddies they select are also trained, conscientious, and mature. Before ever leaving home for the dive site, they take the time to go over their equipment and have it professionally repaired if necessary. They do not wait until they are gearing up at the dive site to discover that their regulator hoses leak or that the batteries in their lights are dead.

Before ever getting to the cavern-diving site, they are well practiced—**overtrained**—in all their cavern-diving skills and emergency procedures. These skills and procedures must be so well learned that they are second nature, so that when you are under stress, you will be able to do them automatically. Even mental thought rehearsals are helpful in programming yourself to respond appropriately. As cave-diving author Mary F. Brooks has so aptly put it: "Safety results only when there is an intimate relationship between the diver, his self-awareness, skills, equipment, and the environment."

At the dive site, the cavern diver should make a deliberate effort not to allow himself to be time-pressured while gearing up or to inadvertently time-pressure others, either in the water or out. Because he is aware of the various sources of stress, such as task loading, depth and distance concerns, and ego threats, the cavern diver can be on his guard against them and can break the chain of events that is producing the stress.

In the water, again, the key is prevention. If you are on the lookout for the early signs of stress both in yourself and in your buddies, you will be able to reverse the stress spiral before it gets out of control. Temporarily halt the dive if you have or perceive a difficulty. If a diver is nervous about the increasing distance between himself and his buddies, this will allow him time to catch

up. If he is over-exerting this will allow him to catch his breath. If there is an equipment problem that has to be attended to, this will simplify things for you by allowing you to deal with the problem without the additional concerns of trying to swim and navigate through the cavern at the same time. If you are uncomfortable with the increasing distance and depth between you and the surface, this will put an immediate stop to it.

If the problem cannot be solved with a temporary halt, then turn the dive and head out of the cavern. Just the knowledge that they are swimming out of the cavern rather than into it, can be enough to calm some stressed divers. The bottom line is simply this: there is no sound reason to justify continuing a dive if you or your dive buddy is uncomfortable. Experience and seasoning both require time.

Chapter 10

Emergency Procedures

Scuba diving entails a certain amount of risk. Poor diving techniques or unanticipated equipment failures may create conditions that compromise diver safety. Stress induced by these situations may lead to poor diver performance and, perhaps, to the development of other diver-related emergency conditions. For example, a diver near panic due to a regulator failure may totally silt the cavern trying to correct the problem and in the process worsen the dive team's predicament. However, a diver practiced in emergency procedures is more likely to react appropriately without causing other additional problems. Specific, orderly, proven procedures have been devised for dealing with these cavern-diving emergencies. These procedures combine all of the techniques that you have learned up to now. Before going into the cavern, you should practice the procedures in open water with all your dive buddies until you know them so well that you can act reflexively and quickly, and you can perform them easily even under the worst conditions.

Loss of Visibility. Loss of visibility is probably the most common problem experienced by cavern divers. It happens for two reasons, which can occur singly or in combination: loss of light and increased turbidity of the water. But whatever the reason, the net result is the same—limited or non-existent visibility. The consequences of this are possible loss of navigational light from the surface, potential loss of visual communications with buddies, inability to monitor gauges, inability to see the line, and isolation of the divers due to the potential breakdown of the buddy system.

The loss of visibility can occur gradually, as when silt is kicked up in the cavern over the course of a dive, or it can be virtually instantaneous, due either to failure of a hand-held light or sudden, massive silting.

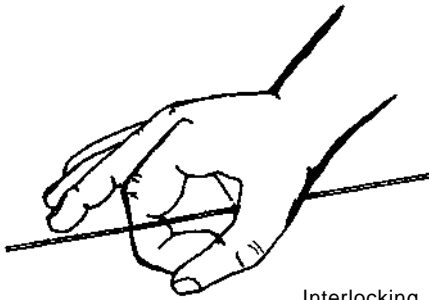

Interlocking
OK around
the line

As a cavern diver, you should be within arm's length of the line at all times. If a light fails, stop, make an interlocking OK around the line, activate your back-up light, signal your buddy, and exit the cavern. If visibility is lost due to silting or failure of all battery-powered lights, make an interlocking OK around the line, turn to exit, connect with your

buddies, use touch-contact communication as required, and exit the cavern.

Entanglement. Upon noticing that you have become entangled in the line, stop; swim no further. Signal your buddy with your light that his attention is required. There is no emergency as yet. Once your buddy's attention has been confirmed, make an attempt to free yourself. If this does not succeed then stop. Further attempts may only make things worse. Inflate your BC if necessary to remain above the floor and wait for your buddy to come to you to clear the entanglement.

If your buddy does not immediately respond, continue to rest and wait. It may require several moments for him to return to you, but you should have plenty of air left. Once the entanglement is cleared, decide if the dive continues or is terminated.

Should your buddy fail to respond to your request for aid, or visibility break down, then assume an emergency is developing. Continue to remain calm and find a location to secure or tie off the line. Assume a self-rescue is needed, but do not cut the line until all divers have been accounted for and are on the outbound side of the severed line. Exit the cavern and surface. You can return later with fresh tanks to retrieve the line and/or reel.

Lost Diver. If you are on the guideline and your buddy is lost (i.e., out of sight and off the guideline), hold your light against your chest so as to block the light off (do not turn it off! - lights that are turned off do not always turn back on) and look for the glow of his light. If you see it, swim over to him with the reel. Then exit the cavern, because you have had a serious buddymanship problem that needs attention on the surface.

If you do not see the glow of his light, you should secure the guideline by tying it off. This establishes a firm reference point. Then swim along the line, using your light as a beacon, slowly moving it back and forth in wide arcs. It may be easier for your buddy to see your light than it is for you to see him or his light.

If this doesn't work, use whatever line remains on the reel, and search the cavern in an arc from the tie-off made when diver was discovered to be lost. The amount of time you spend searching is dependent on your own air supply. When you have spent whatever time you can searching, tie off the reel (on the chance that your lost buddy might find it and be able to find his way out), and then exit. Do not jeopardize your safety searching for a buddy who may have already exited the cavern. If he hasn't exited by the time you surface, then he must perform his own self-rescue.

If you are the lost diver, stop as soon as you realize you're lost. Swim no further. Inflate your BC to rise up to the ceiling, if you are not already at the ceiling. Search for your buddy's light. If you see it, swim to it. If not, shield your light against your chest and let your eyes accustom themselves to the darkness. (This may take several moments, but this will allow you time to plan your evacuation.) If you still can't see his light, look for the daylight of the entrance. Exit, surface, and if your buddy is not on the surface, then swim down to where your line enters the cavern and, air permitting, go back in along the line to look for your buddy.

If upon rising to the ceiling of the cavern, you were unable to see either your buddy or the surface light, then chances are they are obscured by localized silting. Remain still and on the ceiling with your light shielded against your chest. As the silt clears, the visibility may return to reveal either your buddy's light or the surface light. Should this prove to be ineffective, then look for your own silt trail and follow it. If the silt trail is not clearly evident or you want to confirm it, check your compass. In a high-outflow cave, look for the current direction and follow it. If you're in a siphon cave, swim out against the current. At this point, assume that you're on your own and that you must effect your own rescue.

Problem-Solving Time. The difference between a mere nuisance and a full-fledged emergency is time—or air. If you have plenty of air, then an entanglement, silting, or even light failure is primarily a nuisance. These things do not assume emergency

proportions until you're low on air.

Out of Air. Signal emergency, then sign OUT OF AIR. Implement air-sharing procedures, OK around the line, and exit the cavern.

This process sounds straightforward enough, and it is. Should you have an air failure, it should be reassuring to know that you will be sharing air with one of the buddies with whom you practiced this skill only moments before the dive. However, this assumes that the visibility is good enough that you can easily see your buddy to communicate with him and get his octopus.

As soon as the visibility deteriorates, you should be in touch contact with the line, and in touch contact with your buddies. If you have an air emergency under these circumstances, then you will have no way of indicating your need to your buddy other than to grab the regulator that you used during the S-Drill. However, at least you are in touch contact with the line and can follow it to your buddy.

Once you've taken care of the initial concern (getting air to breathe) then your problem becomes how to navigate along the line while sharing air. How you do this depends on the exact nature of your octopus rig—whether it's a 5- or 7-foot long-hose octopus, or a short-hose octopus. Having a long hose simplifies matters considerably. You can swim single file, with both divers on the same side of the line in touch contact, both making the OK sign around the line, with the donor either in front or back.

With the short hose, you will have to make compromises. One method is for the divers to go out piggy back, one on top of the other. Its primary advantage is that it keeps both divers on the same side of the line. If there are only minor obstacles, this is the fastest way out. One disadvantage is that the diver on top might not be able to reach the line, and would have to rely entirely on his buddy for navigation. Another disadvantage is that if they have to swim under anything, the diver on top may not fit through, forcing them to switch to another position, delaying the exit. Should the diver on top, who might not be in contact with the line, hit the object, he might fall off.

Another alternative is for the two divers to share air side by side, on either side of the line. The chief advantage is that they can both be on the line and can much more easily deal with overhead obstacles. But they will have a very difficult time maneuvering around obstacles, and if the line is laid along a wall, they will

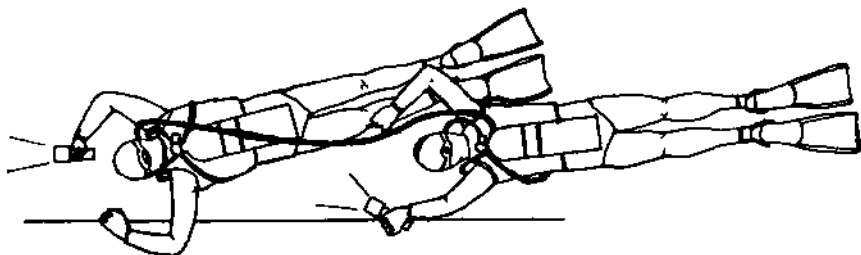

Air sharing under low-visibility conditions made easy with a long hose

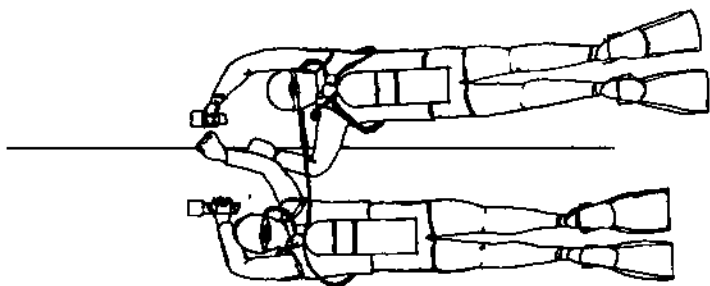

Air sharing under low-visibility conditions with a short hose (side by side on opposite sides of the line)

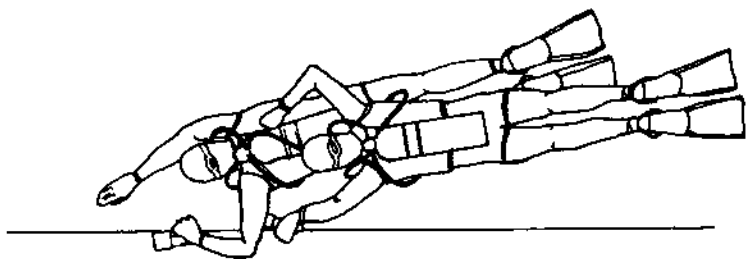

Air sharing under low-visibility conditions with a short hose (on same side of the line)

either have to swim sideways, or one of them will end up coming out upside down—an exercise which works only in theory. No matter which arrangement they choose, their exit will be considerably delayed with a short hose.

Experienced cave divers enjoy playing a unique game called "What if....?" where real and imagined emergency scenarios are presented for solution. "What if...?" allows shortcomings in procedures, strategies, and equipment to be uncovered and corrected on dry land or under very controlled circumstances. It also explains why—even for a routine dive in a familiar system—cave divers tend to look like they're going to an alien planet, what with all the extra tanks, regulators, lights, reels, helmets, and other paraphernalia they carry. By trying to anticipate potential crises and being well equipped for and practiced in dealing with them, trained cave divers are able to resolve most problems long before they are ever allowed to evolve into true emergencies. While cavern divers do not have to plan for such extensive contingencies, the keys to satisfactorily managing emergency situations are the same: anticipation, preparation, practice, and prevention.

Chapter 11

An Open Letter from the NSS Cave Diving Section to Prospective Cavern Divers

As you were reading through this manual, you may have wondered just how we arrived at some of the cavern-diving procedures and limitations that we have set forth—the 130-foot maximum linear-distance rule, the 70-foot maximum-depth rule, the air rules, the use of the guideline. On the surface, some of them may appear to be arbitrary. The sad fact of the matter is that they were arrived at by a careful analysis of underwater cave accidents.

Since 1948 there have been 312 scuba-related drownings in North American caves as of this writing. It was found that every single instance could be reduced to a common denominator of one or more of only three relevant factors which directly contributed to the deaths. The victim or victims had:

1. Failed to run a continuous guideline from outside the cave entrance.
2. Failed to reserve at least 2/3's of their starting air for the trip out of the cave.
3. Exceeded the depth limitation for their level of training.

What these three factors pointed to in almost every case was a complete lack of any form of cavern- or cave-diving training. In the very few cases involving divers who were trained in cave diving, their deaths were directly attributable to deliberate violations of accepted cave-diving safety practices—or in other words, having the training, but ignoring it.

One of the more startling aspects of the statistics is that no

less than 20 of the "victims" were certified open-water instructors, many with several years of open-water diving and teaching behind them. But not one of them had cavern- or cave-diving certification. This, if nothing else, should point to the overwhelming conclusion that no amount of previous open-water experience can adequately prepare you for the environmental requirements of cavern or cave diving.

In addition to the three primary rules of the line, air, and depth, accident analysis has yielded a fair number of other frequent contributory factors. Ranking high on the list is failure to carry adequate lights—both in terms of the number of lights and their anticipated burn time. (It doesn't make much sense to plan a dive that's supposed to last longer than the expected burn time of all the lights, but it happens.) Alcohol intoxication, and use of marijuana and other drugs prior to the dive have also figured in on some of the fatalities. Insufficient scuba (in the form of single regulators with no octopus second stages, submersible pressure gauges, or BC auto-inflators) has also played a role. But while these items—or lack thereof—were no doubt contributing factors, they primarily serve to reinforce the overwhelming evidence that lack of training is the Number One cause of underwater cave death.

The empirical data are incontrovertible: historically, there is a 100% correspondence between dying in underwater caves and not having (or using) the appropriate training. This is not to say that if you are trained and dive within your limitations and take every possible precaution, that you absolutely cannot die in an underwater cave. But it is to say that if you dive within the limitations of your training and equipment, and abide by all the recommended safety procedures, you are statistically in a very low-risk category. Your chances of being the fatal victim of a drunk driver on the way to the dive site are much greater than of being the victim of a so-called "killer cave."

Working backwards from the results of the analyses of underwater cave accidents, the NSS Cave Diving Section has developed the following recommendations for safe cavern and cave diving, which we call the "Rules of Accident Analysis."

1. Be trained in cavern or cave diving and dive within the limitations of your training.

2. Always run a single continuous guideline from the entrance of the cave.
3. Always reserve AT LEAST 2/3's of your starting air for the trip out of the cave.
4. For cave divers, properly equipped and trained, never dive below 130 feet. For cavern divers, properly equipped and trained, never dive below 70 feet.
5. Have at least 3 separate light sources per diver. For cavern divers, these are the sun and at least 2 battery-powered lights. All lights should have a burn time greater than the planned length of the dive.

The NSS-CDS Cavern Diving Course was developed specifically to meet this need—to allow divers with mostly open-water equipment to take a safe look at our world with the absolute minimum investment in equipment and training. This book was written as an adjunct to that course, but is in no way intended to serve as a substitute for it. Just as no amount of open-water experience can adequately prepare you for the trials of the cavern environment, neither can just reading a book about it. You need to "drown" a couple of times on simulated cavern dives in open water to really begin to appreciate the full force of the need for TRAINING, as opposed to just book knowledge.

If you are reading this book as a fully trained cavern diver, please remember that, because you are still diving primarily with a basis of normal open-water gear, it is vitally (and we mean that literally!) important that you confine yourself to the light, depth, and penetration limitations prescribed for "cavern diving." To go beyond these limits is to "cave dive." And without the extra training and equipment needed for cave diving, you have moved right back into the high-risk accident category. Before you decide to extend your diving past cavern-diving limits, we urge you to make the additional investment in a cave-diving course taught by a certified cave-diving instructor.

NSS/NACD CAVERN DIVER COURSE DESCRIPTION

I. Purpose

The course develops the minimum skills and knowledge for cavern diving, and describes the dangers involved with cave diving. Planning, environment, procedures, techniques, problem solving, and other specialized needs of cavern diving are covered.

Problem solving in cavern diving includes, but is not limited to: body positioning (trim), buoyancy control, emergency procedures, line following, and propulsion techniques. Accident analysis forms the basis of this learning experience. Special emphasis on the unique environment includes silting, entanglement, disorientation, and equipment modifications. The Cavern Diver Course is in no way intended to provide instruction for cave diving.

II. Course Duration

Approximately two (2) days

III. Prerequisite

Basic scuba diver certification (advanced diver training recommended) or the equivalent.

IV. Classroom and Lecture (Approximately 7 hours)

Classroom discussions cover these topics: Policy for cavern diving, environment, accident analysis, psychological considerations, equipment, body control, techniques, and emergency procedures.

V. Land Drills

- A. Guideline use
- B. Guideline following
- C. Emergency procedures

VI. Open-Water Drills

- A. Guideline use
- B. Following line with no visibility
- C. Sharing air
- D. Emergency procedures

VII. Cavern Dives

Three Cavern dives to be conducted in two (2) different caverns and to include:

- A. Safety drill (share air and equipment check on each dive)
- B. Demonstrate buoyancy-compensator use and body positioning via weighting and distribution
- C. Demonstrate specialized propulsion techniques
- D. Guideline and line-reel use
- E. Explore cavern

VIII. Limits

- A. Daylight and free-ascent zone of cavern
- B. 130 feet linear distance from surface
- C. 70 feet maximum depth
- D. 40 feet minimum visibility
- E. No decompression diving
- F. No restrictions (areas too small for two divers to pass through side by side)

IX. Equipment (Minimum)

Mask and fins (straps taped if required), but no snorkel. At least 50 cubic feet of air with minimum 2000 PSI at beginning of dive. Single-hose regulator with submersible pressure gauge, octopus second stage, and power inflator for buoyancy compensator. Submersible repetitive dive tables, exposure suit, buoyancy compensator, plus knife (recommended arm or chest mount), and two (2) battery-powered underwater lights. Also, one per team: watch, depth gauge, reel.

X. Text: *NSS Cavern Diving Manual*

XI. Student-to-instructor Ratio

- A. Maximum field-exercise ratio - 9:1
- B. Maximum in-cavern ratio - 4:1

XII. Certification

The minimum age for certification as a Cavern Diver is sixteen (16) years of age. Applicants less than the minimum age may participate in the class at the discretion of the instructor.

UNIVERSAL CAVERN DIVER COURSE DESCRIPTION

I. Purpose

The course develops the minimum skills and knowledge for cavern diving, and describes the dangers involved with cave diving. Planning, environment, procedures, techniques, problem solving, and other specialized needs of cavern diving are covered.

Problem solving in cavern diving includes, but is not limited to: body positioning (trim), buoyancy control, emergency procedures, line following, and propulsion techniques. Accident analysis forms the basis of this learning experience. Special emphasis on the unique environment includes silting, entanglement, disorientation, and equipment modifications. The Cavern Diver Course is in no way intended to provide instruction for cave diving.

II. Course Duration

Approximately two (2) days

III. Prerequisite

Advanced diver training or the equivalent.

IV. Classroom and Lecture (Approximately 7 hours)

Classroom discussion cover these topics: Policy for cavern diving, environment, accident analysis, psychological considerations, equipment, body control, techniques, and emergency procedures.

V. Land Drills

- A. Guideline use
- B. Guideline following
- C. Emergency procedures

VI. Open-Water Drills

- A. Guideline use
- B. Following line with no visibility
- C. Sharing air
- D. Emergency procedures

VII. Cavern Dives

Three Cavern dives to be conducted in two (2) different caverns and to include:

- A. Safety drill (share air and equipment check on each dive)

- B. Demonstrate buoyancy-compensator use and body positioning via weighting and distribution
- C. Demonstrate specialized propulsion techniques
- D. Guideline and line-reel use
- E. Explore cavern

VIII. Limits

- A. Daylight and emergency-ascent, zone of cavern
- B. 130 feet linear distance from surface
- C. 70 feet maximum depth
- D. 40 feet minimum visibility
- E. No decompression diving
- F. No restrictions (areas too small for two divers to pass through side by side)

IX. Equipment (Minimum)

Mask and fins (straps taped if required), but no snorkel (If snorkel is used, it is to be removed and clipped to the guideline prior to entering the cavern). At least 50 cubic feet of air with minimum 2000 PSI at beginning of dive. Single-hose regulator with submersible pressure gauge, octopus second stage, and power inflator for buoyancy compensator. Submersible repetitive dive tables or meter, exposure suit, buoyancy compensator, plus knife (recommended arm or chest mount), and two (2) battery-powered underwater lights. Also, one per team: watch, depth gauge, reel.

X. Text: *NSS Cavern Diving Manual*

XI. Student-to-instructor Ratio

- A. Maximum field-exercise ratio - 10:1
- B. Maximum in-cavern ratio - 2:1
 - 1. Note: During Demonstration portion of Cavern Dive #1 ratio may increase to a maximum of 4:1 with qualified Divemaster and/or Assistant Instructor participating.
 - a. Student-to-Divemaster/Assistant Instructor Ratio - 1:1.
 - b. Student-to-Divemaster/Assistant Instructor Ratio - 1:1 (Tour portion of Dives # 2 & 3).

XII. Certification

Minimum certification age for Cavern Diver is 18 years old.

CAVERN DIVER COURSE STUDENT OUTLINE GUIDE

- I. Limits of Cavern Diving Course
 - A. "Cavern": daylight/emergency-ascent zone
 - B. Minimum equipment requirements
 - C. Not a cave-diving course

- II. Conservation and Landowner Relationships
 - A. Leave cave as it was found
 - B. Remove no souvenirs
 - C. Develop and maintain good landowner relations

- III. Environment
 - A. Types of caves and their formation
 1. Coral Caves
 - a. Smallest
 2. Sea caves
 - a. Wave action
 3. Lava tubes
 - a. Volcanic action
 4. Solution caves
 - a. Longest and most complex
 - b. Formation
 - (1) Layers of sediment (bedding planes)
 - (2) Aggressive (CO₂-rich) water dissolves limestone (follows path of least resistance)
 - (3) Source of water: drainage area (aquifer) - hydrostatic head
 - c. Physical characteristics
 - (1) Spring (resurgence) head pool - cave run
 - (2) Siphon (insurgence)
 - (3) Spring-siphon
 - (4) Sump (termed siphon by dry cavers)
 - (5) Underground lake
 - B. Visibility
 1. Particles - silt (sand, mung, mud, and clay)
 2. Chemicals - hydrogen sulfide, tannic acid
 - C. Hazards
 1. General hazards
 - a. Dark
 - b. Water

- c. Ceiling
- 2. Specific hazards
 - a. Current
 - b. Silt
 - c. Restrictions (not for cavern divers)
 - d. Passage configuration
 - e. Line traps

IV. Accident Analysis

Three direct reasons why people die in caves, one major contributory cause and one basic NSS-CDS recommendation for any cave environment:

1. Be trained (major contributory cause)
2. Run a continuous line throughout dive (#1 direct reason)
3. Reserve at least 2/3's of your beginning air for exit (#2 direct reason)
4. Do not dive at depths beyond your level of training (#3 direct reason)
5. Use at least three independent light sources (with the sun as your main light)
 - a. Cavern divers may use two lights as the sun is your third light
 - b. There are no cavern dives after dark, only cave dives

V. Equipment

A. Vision

1. Mask (no snorkel)
2. Lights - 3 sources
 - a. Daylight
 - b. Primary
 - c. Secondary

B. Propulsion

1. Power fins, taped to prevent snags

C. Air supply

1. Redundant (decreases chances of failure)
2. Second stage (for air sharing)
3. Singles vs. doubles
 - a. Single (adequate for cavern diving)
 - (1) Familiar
 - (2) Easier to handle
 - (3) Redundant with dual-orifice manifold
 - b. Doubles
 - (1) Heavy and cumbersome

- (2) BUT, with dual-valve manifold, offers redundant regulators and twice the reserve
- D. Body control
 - 1. BC with inflator
 - a. Necessary due to changes in depth and resultant changes in wetsuit volume
 - 2. Weights - pull diver out of trim, redistribute
- E. Cold
 - 1. Wetsuit
 - 2. Drysuit
- F. No-decompression monitors
 - 1. Watch
 - 2. Depth gauge
 - 3. Dive tables or meter
 - 4. Slate and pencil
- G. Navigation equipment
 - 1. Line reels
 - 2. Compass
- H. Other equipment
 - 1. Snap links
 - a. Attach equipment to your body
 - 2. Knife
 - a. Better if worn on arm or chest area (easy to get to)
- VI. Procedures (Planning)
 - A. Pre-planning
 - 1. Pick site and gather information about the site
 - 2. Check gear (checklist)
 - B. Air supply
 - 1. 1/3 Rule: for buddy emergencies.
 - a. Round initial reading down to first number easily divisible by 3.
 - b. Subtract 1/3 of this number from initial reading.
 - c. Turn around on new number (2/3 of initial reading).
 - 2. Example: minimum initial pressure - 2000 psig
 - a. Minimum to use with 1/3 Rule
 - b. In 600 psi
 - c. Out 600 psi
 - d. Buddy/emergency 800 psi
 - 3. Minimum volume
 - a. 50 cubic feet
 - b. Most prefer larger cylinders (71.2 or 80 cf)
 - c. Air system works best when all buddies use same size

cylinders with same fill

C. Communication

1. Many existing sets of hand signals - check with buddy
2. Review signals
3. Use slate

D. Navigation

1. ALWAYS USE LINE
2. Watch line placement - tie only when necessary
3. Use backup referencing
 - a. Watch entrance
 - b. Use compass
 - c. Pay attention to formations

E. Buddy check

1. Air turn-around (write down)
2. Light sources (turn on and check)
3. BC inflator (test)
4. Knife, watch, compass, tables, slate, pencil, depth gauge
5. Test ALL regulators (breathe through)
6. Practice sharing air (Safety drill - S-drill)
7. Check tables for no-decompression limits

F. Plan turn-around - REMEMBER: Anyone can call any dive at any time for any reason.

G. Time

1. Call out time before leaving surface

VII. Techniques

A. Body control

1. Buoyancy of wetsuit changes with depth, use BC, adjust
2. Factors involving trim
 - a. Position of weights
 - b. Position of BC
3. Drag - caused by poor trim
4. Crossing line
5. Silting caused by fin downblast

B. Propulsion

1. Modified flutter kick
2. Shuffle kick
3. Frog kick
4. Pushoff - ceiling walking
5. Pull and glide - using hands
6. Minimize silt and percolation
7. Maximize speed and efficiency

C. Line following

1. Remain within arm's length
 2. Stay close but don't touch unless low visibility
 3. Don't pull or tug on line
 4. Be aware of line location
 5. Use compass when stopping
- D. Line laying
1. Watch placement
 2. Tension
 3. Watch buddies when turning corners
 4. Order of buddies on line
 5. Line can be more dangerous than useful
- VIM. Psychological
- A. Panic
1. Stress - hyperventilation - more stress - panic
 2. Relax, breathe deeply and slowly, find problem
- B. Source of stress
1. Time pressure
 2. Task loading
 3. Exertion and cold
 4. Directional requirements
 5. Equipment out of adjustment
 6. Buoyancy problems
 7. Ego threat
 8. Physical threat
 9. Combination of the above
- IX. Accident Prevention Procedures
- A. Training
1. This is a cavern-diving course, not cave-diving
 2. Get continued education for cave diving
 3. Practice what you have learned
 4. Set limits and discuss these with your buddy(ies)
- B. Run a continuous line to a point outside the cavern
1. Visibility loss
 - a. "OK" on line
 - b. Turn to exit
 - c. Wait on buddy
 - d. Touch/contact communication
 - e. Exit
 2. Primary-light failure
 - a. Stop
 - b. "OK" on line

- c. Activate backup light
- d. Signal buddy
- e. Exit
- 3. Lost diver (separated buddies)
 - a. Your buddy is separated from line
 - (1) Stop
 - (2) "OK" on line
 - (3) Search with light
 - (4) Search with line
 - (5) Do not jeopardize your safety searching for a buddy that may have already exited cavern
 - (6) Exit
 - b. You are separated from line
 - (1) Look for buddy's light
 - (2) Look for cavern exit
 - (3) Look for line
 - (4) Stop and go to ceiling
 - (5) Look for silt trail
 - (6) Use compass and current direction to find entrance
 - (7) Self-rescue
- C. Allow at least 2/3's of your beginning air supply to exit
 - 1. Loss of air
 - a. Signal "Emergency" - "Out of air"
 - b. Share air
 - c. "OK" on line
 - d. Exit
- D. Avoid deep areas
 - 1. No decompression diving
 - 2. Nitrogen narcosis
 - 3. Other gas problems

X. Summary

- A. Cavern definition
- B. Limits
- C. Safety Recommendations

XI. Other Cavern-related Materials

- A. Cave diving is beyond the normal definition of "sport diving"
 - 1. Contact NSS-CDS or NACD for cave-diving training
 - 2. Requires very special equipment and training
- B. Emergency Rescue or Recovery Needs
 - 1. Requires highly specialized training
 - 2. Contact help 24 hours/day - NCIC phone (904) 633-4159

CAVERN DIVER COURSE FIELD EXERCISES GUIDE

I. Equipment Critique

- A. Review of all students' equipment
 - 1. Eliminate areas of potential line entanglement
 - 2. Corrections for trim
 - 3. Weight distribution
 - 4. Ease of handling equipment inside cavern
- B. Use of instructor's equipment
 - 1. Ideas for modification, rigging, etc.
 - 2. "Ideal" streamlining

II. Land Drills

Purpose: A series of "dry" runs to introduce students to techniques they will utilize in actual cavern dives

- A. Line drills (familiarizing students with use of line)
 - 1. Line laying
 - a. Instructor to lay line, making use of local obstacles to introduce students to pitfalls of unnecessary tie-offs, crossings, etc.
 - (1) Provide areas for line crossing
 - (2) Crossed lines (false leads)
 - (3) Tie-offs vs. placement
 - (4) Line traps
 - (5) As required to meet needs of class
 - 2. Student line following
 - a. Student to follow line with eyes open (do not touch) - a referencing exercise
 - b. Students time their pace (walk at normal pace)
 - 3. Low visibility
 - a. Repeat above but with eyes closed
 - (1) "OK" on line
 - (2) Instructor tests proper line technique
 - a. Pull on line
 - b. Student again times self
 - 1. Usually more time than with sight
 - 2. Potentially "lost" on false lead
 - 3. Emphasized air-rule planning
 - 4. Emphasizes continuous line use
 - (3) Touch-contact communications
 - a. Begin with critique of above exercise - "What

- it's" - to emphasize needs for communication
- b. Demonstration of technique by instructor
 1. "OK" on line
 2. Forward
 3. Backward
 4. Hold
 5. Line
 6. Emergency (Out of Air)
 7. Others as necessary
 - c. Repeat #2 with students using touch-contact method of communication
 - d. Complete summary and critique by instructor
- (4) Student line use
- a. Each student (in teams of 2 or 3) to act as team leader (and buddy) to lay line
 1. Allows student opportunity to become acquainted with reel and line use out of water
 2. Student begins self-critique

III. Open-Water or Pool Drills

Purpose: Transfer techniques introduced in land drills to open water (increase task load).

Note: Use the shallowest water that will permit the drills.

A. Pre-dive plan

1. Review open-water drill with students as if it were a cavern dive
2. Cover all aspects of dive

B. Equipment check

1. Instructor to lead equipment check
 - a. Demonstrate technique
2. Students to use all cavern gear (minimum)

C. Bubble check/ dangle check

1. Self-explanatory

D. S-drill

1. Each student conducts S-drill as donor and recipient

E. Shallow open-water course#1

1. Instructor to lay underwater line course to simulate cavern dive
2. Students (in assigned teams) to follow line course for reference dive
3. Repeat item 2 but simulate low visibility
 - a. Eyes shut

- b. Touch contact
- 4. Repeat item 3 but simulate out-of-air emergency
- 5. Surface for full "dive" debriefing and critique by instructor at end of each line course
- F. Line course #2
 - 1. Repeat above but have students switch position (leader or buddy)
 - 2. Line course need not be re-laid as same can be accomplished by having students reverse course
- G. Reel and line use
 - 1. Each student to practice use of reel and line-laying techniques in open water
 - a. Students work in teams

IV. Cavern Dives (3 dives in 2 different caverns)

Purpose: As student becomes indoctrinated into procedures through land and open-water drills, he is now ready for practical experience.

- A. Pre-cavern dive check
 - 1. Pre-dive planning
 - a. Instructor outlines dive and leads students through typical (dry) pre-dive plan
 - 2. Equipment check
 - a. Student team members conduct equipment check under instructor supervision
 - 3. Bubble check/dangle check
 - a. Students conduct same under instructor supervision
 - 4. S-drill
 - a. Students conduct same under instructor supervision
 - 5. Plan review
 - a. Students conduct same under instructor supervision
- B. Demonstration dive (cavern dive #1)
 - 1. Instructor to lay line in cavern in an appropriate manner
 - a. Demonstrate proper line-laying technique
 - 2. Student familiarization dive with cavern
 - a. Instructor checks for buoyancy control, body trim, and weight distribution
 - b. Instructor makes minor adjustments as appropriate
 - 3. Instructor to demonstrate 3 (minimum) anti-silting propulsion techniques
 - 4. Students to practice these techniques while following line course
 - a. Instructor continues to critique
 - (1) Correct techniques

- (2) Students' awareness
- (3) Communications, etc.
- 5. Instructor critique of students
 - a. Debrief dive
 - b. Encourage students to critique their dive, etc.
 - c. Evaluate dive for students
- C. Reel use (cavern dive #2) Note: May use new site or continue with first dive site.
 - 1. Students to run pre-dive checks and drills
 - a. Instructor to observe
 - 2. Student leader to "lead" dive (increase task load)
 - a. Reel use with light
 - b. Line techniques
 - c. Body control, trim, etc.
 - d. Awareness
 - e. Buddy handling of line, etc.
 - f. Debrief
 - (1) Complete critique of students from pre-dive through exiting cavern
- D. Exploratory cavern dive (dive #3)

Purpose: Student to combine past learning experience to plan, execute and evaluate cavern dive.

 - 1. Pre-dive plan conducted by student
 - a. Instructor role plays experienced diver to answer questions posed by students
 - 2. Pre-dive gear check, S-drill, etc.
 - a. Instructor to observe
 - 3. Students to explore cavern
 - a. Instructor to observe
 - 4. Post-dive debriefing by students
 - a. Instructor to observe
 - 5. Dive critique
 - a. Complete critique of dive from start to finish by instructor
 - b. Goal: End on positive points of dive and areas of needed improvement

V. Individual Critique

Purpose: Each student deserves an individual critique of his progress and ability. Specific details may be better understood by students when conducted on private individual basis.

CAVE DIVING AND THE NSS

Founded in 1941, The National Speleological Society (NSS) joins together thousands of individuals dedicated to the safe study, exploration, and conservation of caves. As a non-profit organization affiliated with the American Association for the Advancement of Science, the NSS promotes a variety of scientific, educational, and conservation projects—including grants and scholarships to professional and student biologists, geologists, hydrologists, and archaeologists for cave-related research; purchase of cave properties for the public trust; conservation studies, clean-ups, and restorations; a nationwide rescue-and-recovery network; and a multitude of publications concerning all aspects of cave science, exploration, survey, cartography, photography, and physical techniques.

The first cave-diving information ever published in the United States was in a 1947 *NSS Bulletin*. In 1948, NSS divers were responsible for the first cave dives in the United States using scuba. In 1953, the Florida Speleological Society (a local NSS sub-section or Grotto) conducted the first cave-diver training course complete with written standards. In 1968 an NSS member authored the first American manual on cave diving. By 1973, in response to a growing need to address the particular needs of cave divers, the NSS formed the Cave Diving Section (NSS-CDS). In 1983 the Cave Diving Section was independently incorporated and in 1987 was granted official non-profit tax-exempt status as a scientific and educational organization.

The NSS-CDS has the largest cavern- and cave-diving training program in the world, and is a leader in setting standards for the rest of the cave-diving community. The NSS-CDS was the first to institute the concept of the cavern-diving training, and has certified more than 6000 Cavern and Cave Divers. In addition, the NSS-CDS has a comprehensive instructor training program.

The NSS Cave Diving Section has also trained more than 500 Cave Diving Rescue/Recovery Specialists. In cooperation with the National Association for Search and Recovery (NASAR), the National Cave Rescue Commission (NCRC), and the National Crime Information Center (NCIC), these Cave Diving Rescue/Recovery Specialists are made available to law-enforcement agencies that are affected by underwater-cave-related rescues and recoveries.

The team of cave divers is available 24 hours a day. The NSS-CDS has performed numerous rescues and recoveries throughout the United States and at the request of several foreign governments. If assistance is required by a local law-enforcement agency, it is requested to contact the NCIC or Jacksonville Sheriffs Office at (904) 633-4159.

The NSS-CDS has installed numerous safety/warning signs at some of the more popular underwater caves in the United States, Mexico, and the Caribbean islands. These signs are available for installation in underwater caverns where a risk is perceived. Interested persons are invited to contact the NSS-CDS for more information. The Cave Diving Section, in voluntary cooperation with national, state, county, and private parks, has also developed a "No-Light" rule for open-water divers. This policy, aimed at locations which contain a cavern or cave, prohibits open-water divers from carrying a dive light while diving these waters. The plan has proven very successful, as divers without lights are naturally limited by lack of daylight in their penetration of underwater caverns.

Within the caving community, the NSS-CDS is most renowned for its exploration, survey, cartography, photography, and cinematography of underwater caves. Some of the surveyed systems are more than seven miles in overall length. The Cave Diving Section has also funded scientific studies to examine life forms unique to underwater caves.

While the center of activity remains in Florida, CDS members also dive sumps and mines in the northern states; conduct high-altitude sump dives in the West and Mexico; perform motorized and multiple stage dives in the south; dive sea caves along the Pacific, Atlantic, and Great Lake coastal regions; dive lava tubes in the western United States, Hawaii, and Mexico; and dive blue holes and cenotes in Mexico, Bermuda, and the Caribbean.

The Cave Diving Section has an active publications program, including a bimonthly newsletter, *Underwater Speleology*, and conducts semi-annual Safety Workshops for the exchange of current information on exploration, scientific discoveries, conservation, equipment innovation, and safety techniques. These are held over the Memorial Day and New Year's weekends. The Section has members in almost every state in the Union, and in many foreign countries. Membership is open to any interested individual.

CAVE DIVING AND THE NACD

The National Association for Cave Diving (NACD) was originally established in 1968 with the purpose of achieving safer cave diving through proper training and the development of a maturity in judgment which avoids the hazards of taking unnecessary risks. The organization has evolved to encompass the following goals:

- To establish and maintain up-to-date guidelines in the form of physical and emotional standards, equipment and techniques necessary for safe cave diving.
- To encourage education and dissemination of safe cave-diving practices through the facilities of the organization and to provide for a program of education and advanced training necessary for safe cave diving. The goal of the NACD is not to encourage everyone to cave or cavern dive. The responsibility of the organization is to aid interested divers in becoming safe cavern and cave divers, and to discourage those who may not meet minimum standards.
- To achieve closer cooperation and understanding between members of the cave-diving and sport-diving communities and the general public so that they may work together toward the common cause of accomplishing the goals of the organization.
- To investigate underwater caves and to encourage education and dissemination of the information obtained to government, private industry, and the general public.

To meet these goals the NACD is organized to provide several services including:

Training and Education. The NACD establishes and maintains standards for cavern and cave diving, and cavern- and cave-diving instruction.

Seminars and Workshops. The NACD is active with organizing and planning seminars and workshops, often with the cooperative efforts of other organizations, pertaining to equipment, techniques, safety, education, training and conservation.

Information Services. The NACD publishes and disseminates information pertinent to cavern and cave diving in the form of newsletters, journals, pamphlets, seminar proceedings, training manuals, textbooks, and safety reports.

Membership and Record Maintenance. The NACD maintains records of certified cavern divers, cave divers, and instructors, and well as individual members of the organization.

Conservation. The NACD supports the preservation of the cave habitat and its unique fauna by education, periodic clean-ups at popular dive sites, and sign campaigns.

Research. The NACD is active in studies of accident prevention, management of cave-diving sites, and stress in cave diving, and promotes scientific endeavors relative to archaeology, cave ecology, geology, hydrology and groundwater pollution.

Membership. Voting membership in the NACD is open to all individuals who have successfully completed and become certified through a recognized complete cave-diving course. Associate membership is open to the public and all certified cavern divers regardless of certifying agency and offers all membership benefits except voting. Membership allows you to stay informed of developments in cavern and cave diving, and scheduled courses through an annual subscription to NACD News, the bimonthly newsletter of the NACD, and free NACD Research Bulletins.

NACD Publications. For a complete listing of all NACD publications, contact:

NACD, Inc.
P. O. Box 14492
Gainesville, FL 32604

National Speleology Society
#1 Cave Avenue
Huntsville, AL 35810
Phone (205) 852-1300

The following is a partial list of books and other reference material available to the cavern diver from the NSS. This list comprises the areas of most typical interest to the cavern diver.

The Cave Environment

Glossary of Karst Terminology

Cave Life, David C. Culver

Environmental Karst, Percy Dougherty

Speleology-The Study of Caves, George W. Moore &
Nicholas Sullivan

Basic Cave Diving-A Blue Print for Survival,
Sheck Exley

NSS Cave Diving Manual, ed. Sheck Exley and India F. Young

NSS Cavern Diving Manual, John Zumrick, Jr., M.D.,
J. Joseph Prosser, & H. V. Grey

The Darkness Beckons, Martyn Farr

Basic Underwater Cave Surveying, John Burge

An Introduction to Cave Mapping

An Introduction to Map Reading, Kenneth Thjomson

A Systematic Guide to Making Your First Cave Map,
John H. Ganter

Water Tracers Cookbook

On Rope, Allan Padgett and Bruce Smith

American Caving Accidents (1976-79)

Caving Information Series (Complete Set)

American Caves and Caving, William R. Halliday, M.D.

Cavers, Caves and Caving, Bruce Sloane

The Blue Holes of the Bahamas, Rob Palmer

The Caves Beyond-The Story of the Floyd Collins

Crystal Cave Exploration, Joe Lawrence, Jr. &
Roger W. Brucker

Trapped!, Robert Murray & Roger W. Brucker

- "A lot," 67
- Accident analysis, 76, 97-99
- Acid, 10, 11
- Adrenaline, 88
- Air sharing, 29, 30, 71, 76-9, 84, 87-8, 94-96
- Air supply, 28-9, 76-9
- Air-supply limitations, 76-9
- Air reserve 28-9 76-9
- Alcohol, 98
- Alkaline batteries, 34
- Ambient light, 32
- Anemone Cave, 6
- Ape Cave 8
- "Attention," 61, 63
- "Back up," 70
- Backmounted BC's, 26
- "Back-up light," 68
- Basalt 8
- Batteries 32-5
- "Big " 67-8
- Blue holes, 4, 17, 19
- Booties, 24, 38
- Bowline knot, 51-2
- Breakdown, 21
- "Bubbles " 67
- Buddy breathing, 87-8
- Buoyancy, 39-48, 77
- Buoyancy compensators, 24, 26-7, 31-2, 38-42 45-6
- Burst discs, 29, 38
- Calcite, 9 Egothreats, 84-5, 87, 89
- Calcium carbonate, 5, 9
- Calcium-magnesium carbonate, 9
- Carbon dioxide, 10-1, 88
- Carbonate rocks, 8, 19
- Carbon-dioxide cartridges, 27
- Carbonic acid, 10
- Carlsbad Caverns, 8
- Cave formation, 3-16
- Cave referencing, 27-8, 50
- Cave-ins, 17, 20
- Cavern reel 35-7
- Ceilings, 17, 19, 20, 22, 27, 46, 54
- Ceiling pushoff, 43, 45-7
- Cenotes, 15, 17
- Center of gravity, 25, 39-43
- Chipola River, 13
- Clay, 8, 18-9
- Clips, 25, 32-3, 36
- Clumsiness, 86
- Cold, 24, 85-7
- Collapse sinkholes, 14-5, 21
- Command signals, 64
- Communications, 59-71
- Compass, 27-8, 50
- Conservation, vi, 2
- Coral caves, 5-6, 9
- Coral reefs, 1, 4-6
- "Current," 68
- Currents, 7, 17-20, 23, 45, 47, 57, 74, 78
- "Cut," 68
- Cylumes, 60
- Debris cones, 14
- Decompression diving, 76
- Decompression tables, 27, 85
- Depth gauges, 27, 38
- Depth limit, 74-5, 97, 99
- "Direction to the surface," 66
- Direct-sunlight zone, 22, 32, 74-5
- Dismal Sink, 15'
- Distance limit, 74-5
- Dive lights, 23, 31-5, 37, 49, 60, 63, 91-2, 98
- Dive objectives, 72
- Dive plans, 72-3
- Dive planning, 72-81
- Dive tables, 27
- Dive-team size, 73
- Dolines, 13
- Dolomite, 8-10
- "Down," 68
- Dragon's Breath Cave, 16
- Drainage basins, 12
- Drop weight, 25
- Drugs, 98
- Drysuits, 24
- Dual-valve manifolds, 29
- "Emergency," 61
- Emergencies, 25, 29, 74, 76, 79, 91-6
- Emergency ascents, 22, 50
- "Entanglement," 67
- Entanglements, 23-4, 28, 53-4, 56-7, 77, 84, 88, 92
- Equipment, 22-38
- Exploration reels, 35-7
- Fight-or-flight syndrome, 88
- Fins, 19, 23-4, 37
- First-magnitude springs, 13, 16
- Flint Ridge-Mammoth Cave, 8
- Flow reverses, 17, 19
- Flutter kick, 43
- Frog kick, 43, 45, 47
- Frustration, 86-7
- Gap reels, 35-6
- Geology, 3-16
- "Go," 70
- Gravel, 19
- Groundwater, 10-1
- Guidelines, 20-3, 26-8, 32, 35-7, 49-58, 67-70, 76, 92, 97, 99
- Gyres, 13
- Halocline, 19
- Hand signals, 63

- History, 114-5
- "Hold," 64-5, 69
- "Hold tight to the line," 71
- Hood, 24, 38, 59
- Horse-collar BC's, 26, 41
- Hydrogen sulfide, 19
- Hydrogeology, 10-2
- Hypercapnia, 88
- Hyperventilation, 78, 85, 88, 90
- Ichetucknee Springs, 13
- Impermeable rocks, 9-10
- Jacket-style BC's, 26, 42
- J-valves, 28-9
- Karst, 11-4
- Karst lakes, 14
- Karst ponds, 14
- Karst windows, 15-6
- Kazumura Cave, 8
- Knives, 22, 28, 37
- K-valves, 28-9
- Landowner relations, 2
- Lava-tube caves, 5, 7-8, 17
- Lead-acid batteries, 34-5
- Light limits, 74-5
- Light signals, 59-63
- Lights, 23, 31-5, 37, 49, 60, 63, 91-2, 98
- Limestone, 8-11, 15
- Limy sediment, 9
- Limitations, 74-9
- "Line," 67, 71
- Line following, 20
- Line traps, 17, 20-1, 51, 54-6
- Line wraps, 54-6
- Lines, 20-3, 26-8, 32, 35-7, 49-58, 67-70, 76, 92, 97, 99
- "Little," 67-8
- Little Salt Spring, 4
- Littoral caves, 6-7
- Long hoses, 29-31, 71, 94-5
- Lost diver, 92-3
- Lost Sea (Cave), 16
- "Low on air," 69
- Mammoth Cave, 8
- Marine caves, 5-9, 17-9
- Masks, 23, 37
- Mazes, 17, 20, 49
- Modified flutter kick, 43-5, 47
- Mud, 18,
- Mung, 18
- Narrowing of perception, 86-7
- Ni-cad batteries, 34-5
- Night diving, 17, 59, 74
- "No," 66
- No-decompression limits, 76
- Obsessive behavior, 87
- Octopus restraining strap, 30
- Octopus, 22-3, 29-31, 71, 88, 94
- OK on line, 69-71, 92, 94
- "Okay," 62, 64-6
- Open-shoulder-style BC's, 26, 42
- O-rings, 29, 37-8
- "Out of air," 69
- Out-of-air emergencies, 29-30, 71, 76-9, 84, 87-8, 94-6
- Over-exertion, 78, 85, 90
- Panic, 83, 88, 91
- Pencils, 37
- Permanent lines, 57
- Permeable rocks, 10
- Phreatic zone, 10-1
- Plastic ties, 25, 33
- Ponors, 13
- Post-dive discussion, 81
- Power inflators, 26-7, 29, 77
- Pre-dive check, 79-81
- Pressure gauges, 23, 28-9, 31-2, 38
- Primary tie-off, 50-2, 55
- "Problem," 66-7
- Propulsion techniques, 39, 43-8
- Psychological aspects, 82-90
- Pull and glide, 43, 46-7
- "Query," 66-7
- Quick-release clips, 25, 32-3, 36
- Rainbow Springs, 12
- Recovery, 114-5
- Redundancy, 23
- "Reel," 67
- Reel jams, 52-3, 57-8
- Reels, 22, 35-7, 49-58, 67-68, 70
- Regulators, 22-3, 27, 29-30, 38, 63
- Rescue, 114-5
- Restrictions, 16-7, 20, 74-6
- River Sink, 16
- Safety plugs, 30
- Safety reels, 35-6
- Sand, 5, 18
- Santa Fe River, 13
- S-Drill, 79-80, 94
- Sea caves, 5-7
- Sea life, 6-8
- Sea Lion Cave, 6
- Sealevels, 4, 7
- Secondary tie-off, 50-1, 55
- Shuffle kick, 43-5, 47
- "Silt," 67-8
- Silt, 5-6, 8, 18-20, 25, 35, 39-41, 43-4, 46-7, 49-50, 54, 57-9, 63, 65, 67-9, 74, 76-7, 83, 87, 91
- Silver Springs, 12
- Sinkhole lake, 14
- Sinkholes, 11, 13-5, 17, 19, 21
- Sinking streams, 11
- Siphons, 13, 15, 17, 19, 78-9
- Slack, 50, 52-4, 57, 65

- Slate, 37, 39
- Slick, 13
- "Slow down," 69
- "Small," 67
- Snorkel, 24
- Solo diving, 73
- Solution caves, 5, 8-16
- Speleologist, 5
- Speleothems, 2, 4
- Spring runs, 11-3, 15
- Springs, 4, 11-3, 15-7, 23, 45
- "Stop," 70
- Stalactites, 1-2, 4, 46
- Stalagmites, 1-2, 4, 46
- Streamlining, 22-3, 33
- Stress, 63-5, 78, 83-91
- Submarine springs, 11-2
- Submersible pressure gauges, 23, 28-9,
31,2,38
- Subsidence sinkholes, 14
- Sump lake, 16
- Sumps, 3, 16
- Sun, 31
- "Surface," 64-5, 68
- Surface streams, 11-3
- Swallow holes, 13
- Tank harness, 26-7
- Tanks, 26, 28, 38, 42-3, 76-9
- Tannic acid, 19, 73
- Task loading, 49, 83-4, 89
- Third's rule, 76-9, 97, 99
- Tides, 7, 17-9
- "Tie off," 68
- Time pressure, 83, 89, 93
- Touch contact, 68-71, 92
- Trim, 25-6, 39-48, 52, 63
- "Tunnel," 68
- Turn-around pressure, 76-9, 81
- Twin Caves, 15
- Underground lakes, 16
- "Up," 68
- Vadose zone, 10-1
- Valves, 28-9, 38
- Visibility, 13, 16-20, 55, 57, 60, 69-71,
74, 76-7, 84, 91-2, 94
- Wakulla River, 16
- Wakulla Springs, 4, 16
- Warm Mineral Springs, 4, 12
- Watches, 27, 38
- Water table, 10-1, 16
- Weight belts, 24-5, 42
- Weights, 24-6, 40, 42-3
- Wetsuits, 24-6, 38, 40
- Wings, 42
- "Yes," 66
- Y-valves, 29